

VERSATILE AND ROBUST

Whether for files, liquids, equipment or tools: shelving systems from LISTA offer tailor-made storage solutions for practically all requirements. High load capacities and a distinctly robust design guarantee optimum use of space and high storage capacity. Many shelving systems are now also available in a galvanised version. The more impressive new feature is that the universal shelving system has been completely overhauled to allow even more flexible solutions for a wide variety of working environments.



The right solution for every need



L1006 universal shelving
see p. 220



Heavy-duty pull-out shelving systems
see p. 238



Drawer storage walls
see p. 84



Sliding shelf units*



Storage and sloping shelving systems*



Wide span shelving systems*



Pallet shelving systems*

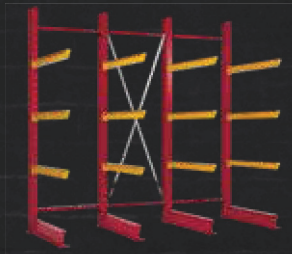

Cantilever shelving systems*



Mobile shelving systems
see p. 246

* For more information, please get in touch.

The impressive feature of the universal shelving system from LISTA is that it is fully modular. Available in two versions – either with shelf supports or with open sides – and a variety of heights, depths and unit widths, the slot-in system is quick and easy to assemble for a wide range of requirements. Individual configuration options with shelves, partitions, drawer units and more produce an orderly, space-saving storage system in which everything is ready to hand. Whether small parts, bulk goods, tools or archive material: the LISTA universal shelving system is the ideal warehouse solution – especially in the lean area.

! ALWAYS WITH LISTA

Choice of colours

12 standard colours, all other colours available; see p. 22. Many shelving systems are also available in a galvanised version.

Intelligent locking systems

Replaceable cylinders that can be fitted to existing locking systems, electronic locking systems via CODE and RFID Lock for absolute security made to measure; see p. 28.

Individual configuration options

in size, equipment, locking system, colour and drawer partitions; see p. 10.

Fully combinable

Standardised dimensions for all LISTA universal shelving systems of varying designs.



+ Utmost stability

Sturdy shelf supports or side panels with a load capacity from 1,000 kg to 2,800 kg per shelving unit

+ High load capacities

80 kg to 350 kg per shelf

+ Generous storage capacity in a small space

Can also be installed as a double-stack set-up on request

+ Fast and easy assembly

Non-screwed, slot-together design of all basic components and shelves simplifies assembly

+ Flexible configuration options

Drawers, clothes rails, organisation rails, pull-out suspension file frames, shelf front cover strips, drip trays, grating covers, etc.

+ Fully modular

Standardised dimensions for all LISTA universal shelving units and customisable configuration options

+ Can be adapted to new storage items at any time

Flexible integration and rearrangement of shelves, drawers and individual parts in increments of 25 mm

+ Secure locking

Choice of hinged doors or space-saving sliding doors in combination with rear panels

+ Ideally suited to lean environments

Perforated rear and side panel covers and sloping shelves for fast, ergonomic access to tools and materials

+ Maximum shelf use

Shelves have an edging height of only 25 mm so that the full storage height is available

+ Fully modular and available in a wide range of versions

All individual parts and accessories of the universal shelving system can be freely positioned and combined with one another in a modular fashion – and this applies to both equipment versions (with shelf supports or with side panel).

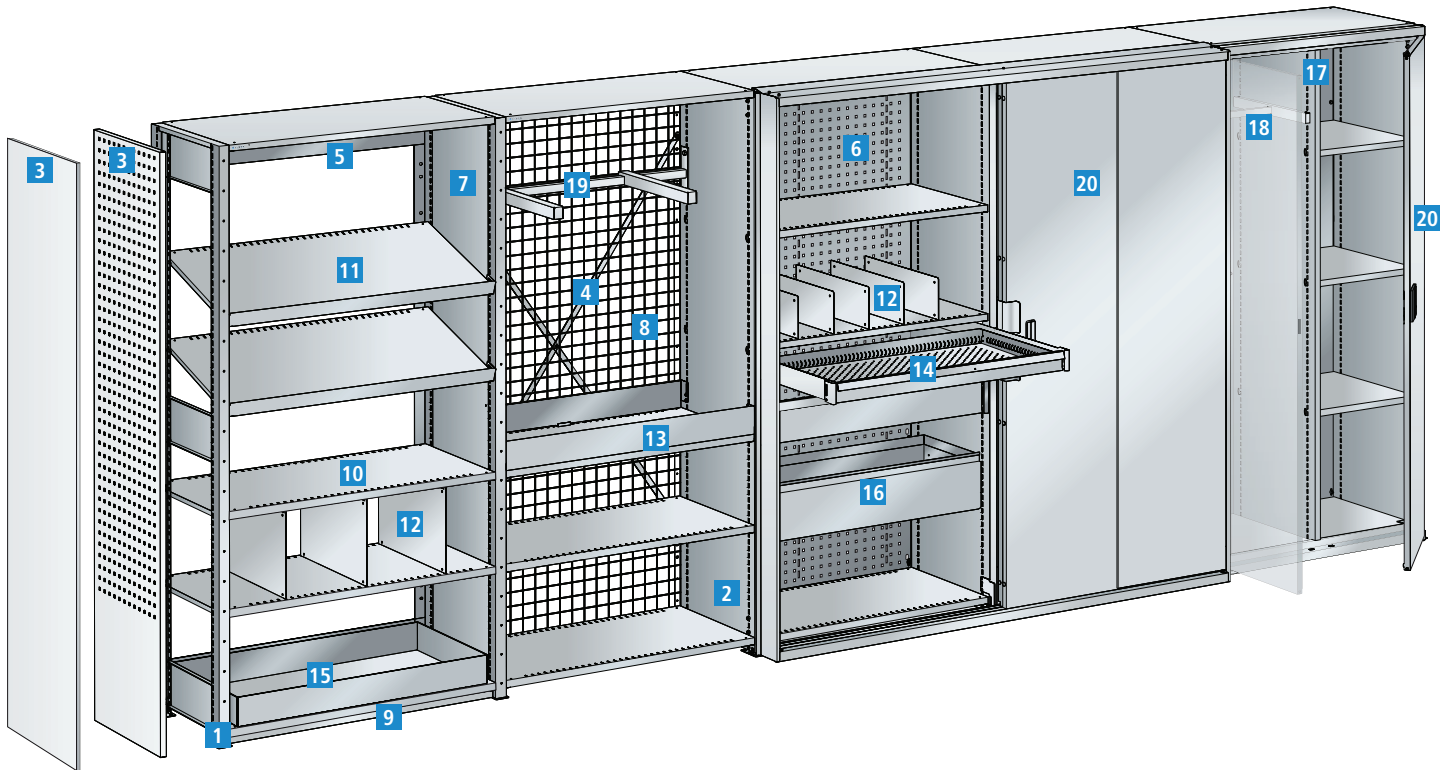

» Dimensions and load capacities, see page 226.

1 Shelf supports

Sturdy, open layout with a maximum load per unit of 2,800 kg, optional extension unit for shelving heights up to 5 m.

2 Side panel

Elegant closed layout with a maximum load per unit of 1,000 kg also prevents the stored items from falling out

3 Side panel cover, plain or perforated

For covering the open shelf supports or the row of slots on the side panels, perforated version for tool hooks

4 Diagonal brace

For stabilising the shelving units lengthwise

5 Lengthwise braces

Used instead of diagonal braces to make both sides accessible

6 Rear panel, plain or perforated

For covering the rear panel of shelving units; also stabilises the units lengthwise, perforated version for tool hooks

7 Partition

Placed between the shelf supports

8 Grating

Can be used as side panel covers, rear panels and partitions, prevents access and yet guarantees visibility and ventilation

9 Base cover

Protects against dust and dirt. Also prevents items from sliding underneath the unit

10 Shelf

High compartment loads of 80 to 350 kg (edge height 25 mm) for maximum use of space, in a choice of plain or slotted

11 Sloping shelf LEAN

Retrofittable stop bars for fitting shelves at an incline, for providing ergonomic access to materials and parts

12 Partitions and shelf dividers

For subdividing slotted shelves, ideal for storing small parts and small boxes

13 Shelf front cover strip

For the neat and tidy storage of bulk goods

14 Drawer

Fully extendable with load capacity of 50 kg for space-saving storage of small parts; extensive range of partition material

15 Drip tray

For storing liquids and for use as a drip tray

16 Pull-out suspension filing frame

Suitable for A4 suspension files; load capacity 50 kg for the orderly storage of and easy access to suspension files

17 Centre partition

For the vertical subdivision of complete shelf units

18 Clothes rail

Perfect for storing clothing and protective workwear

19 Organising rail

For vertical storage, compartment division and for storing ring-shaped materials (cables, vee belts and tubing)

20 Hinged and sliding doors

Secure access and dust protection with hinged doors or space-saving sliding doors, lockable

+ Flexible range of applications

The universal shelf unit offers storage solutions for a wide variety of requirements in workshops and offices. Since it takes ergonomic factors into account and implements the 5S principles, it is especially suitable for lean working environments.



Storage of tools and spare parts

- Perfect order and cleanliness according to the 5S principle



Storage of boxes and containers

- Ergonomic access to materials at the workplace according to lean criteria



Storage of bulk goods

- Structured and efficient storage of bulk goods

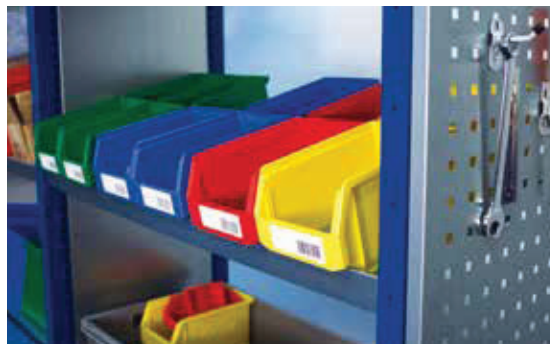

Shelf units with sloping shelves

- Ergonomic access to materials at the workplace



Shelf cabinet system with lockable doors and drawers

- Safekeeping of small parts and tools



Storage of lever-arch files, folders and suspension files

- Well-organized and within reach



Clothing locker shelf units

- Storage of clothing and protective workwear



Double-stack shelving systems

- Optimum use of space

+ Individual configuration options

Typical configurations



L1006 universal shelf unit for the workshop

- Perforated rear panel for holding tool hooks
- Drawers for safekeeping of small parts
- Shelf front cover strips for tidy storage of loose bulk goods
- Organising rail for storing cables and tubing
- Tyre shelves for storing narrow and wide wheels

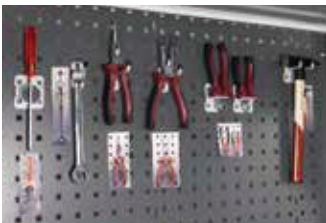

Configure and order L1006 universal shelving individually



Shelf unit floor area

- Choice of shelf dimensions $W \times D$ (e.g.: 1000×500 mm)
- To calculate the external dimension, please refer to the planning instructions on p. 226 / 227



1. Layout and shelving height

- Choice of "shelf supports" or "side panel".
Design combinations available on request!
- Choice of shelving height H
- Optional: shelf support cover, extension units, side panel covers and partitions, floor anchoring, levelling plates



2. Stabilising elements

- Choice of stabilising elements: diagonal braces, rear panels or lengthwise braces



L1006 universal shelf unit for the office

- Elegant, closed side panel
- Pull-out suspension filing frame for orderly, easily accessible suspension files
- Partitions for orderly storage of and easy access to files and folders
- Shelves with an edging height of only 25 mm so that the full height of a file is available

! NEW!
Shelf heights 1,100mm, 1,450 mm and 1,800 mm for 3, 4 or 5 file heights



3. Shelves

- Choice of shelves (plain, slotted) and compartment load
- Optional: Stop bars for sloping shelves, shelf labelling, partitions and dividers

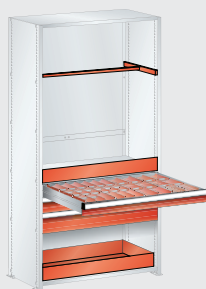

4. Accessories

- Optional: Choice of accessory shelf front cover strips, drawers, partition material, drip trays, clothes rails, Cover panels, etc.
- Choice of tyre compartment level pair for tyre storage, see p. 235



5. Front-mounting fitments

- Optional: Hinged and sliding doors

6. Add-on elements "Office"

- Optional: sideboard

Shelving systems | Universal shelf unit L1006, shelf support layout

Dimensions and load capacities

kg Max. load per unit 2,800 kg with a distance between shelves of max. 750 mm

kg Max. compartment load: 80, 160, 220, 280, 350 kg

Adjustment increment: 25 mm

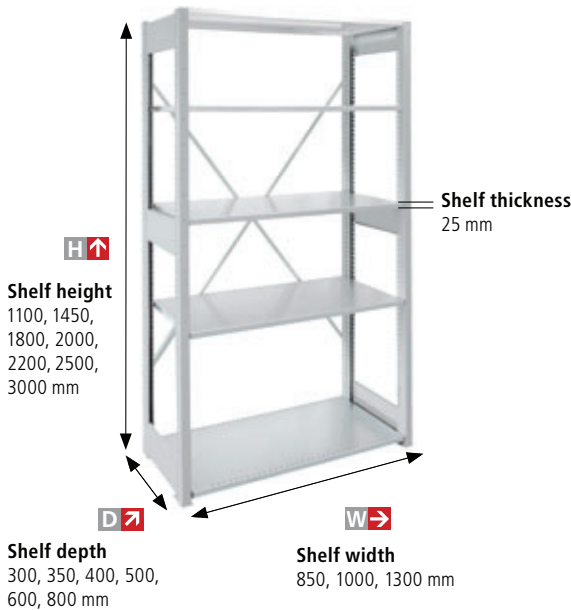

Planning instructions

Calculating the external dimensions

Overall width of shelving: Total shelving widths + number of supports × 40 mm + 10 mm (base plate external)

Overall depth of shelving: Shelf depth + 4 mm

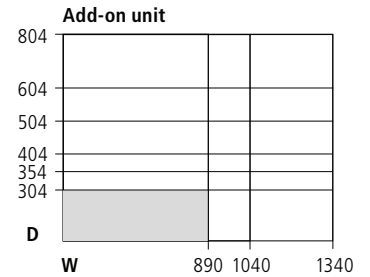
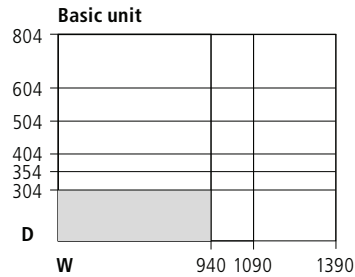

Safety instructions

Anchoring rule Units with a depth to height ratio greater than 1:5 (1:4 for units with hinged doors and single units with drawers) must be anchored. Floor anchoring: Art. no. **130.555.000** (each).

Arrangement of diagonal braces For each basic unit and for each third add-on unit, an extra diagonal brace is required. Instead of diagonal braces, rear panels can be used – or lengthwise braces in order to make the unit accessible from both sides. Diagonal brace: Art. no. **50.026.000**.

Basic and add-on shelf units

Basic unit

2 pairs of shelf supports incl.
6 horizontal braces
1 diagonal brace, galvanised
5-6 shelves, slotted (thickness 25 mm)

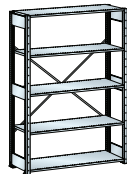

Add-on unit

1 pair of shelf supports, incl.
3 horizontal braces
5-6 shelves, slotted (thickness 25 mm)

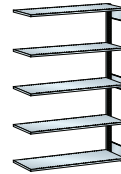

				D 400 mm		500 mm		600 mm	
H	W	Number of shelves	Shelf load kg	Basic unit Art. no.	Add-on unit Art. no.	Basic unit Art. no.	Add-on unit Art. no.	Basic unit Art. no.	Add-on unit Art. no.
2000	1000	5	160	50.200.XXX	50.201.XXX	50.202.XXX	50.203.XXX	50.204.XXX	50.205.XXX
			220	50.236.XXX	50.237.XXX	50.238.XXX	50.239.XXX	50.240.XXX	50.241.XXX
2200	1300	5	160	50.206.XXX	50.207.XXX	50.208.XXX	50.209.XXX	50.210.XXX	50.211.XXX
			220	50.242.XXX	50.243.XXX	50.244.XXX	50.245.XXX	50.246.XXX	50.247.XXX
2500	1000	5	160	50.212.XXX	50.213.XXX	50.214.XXX	50.215.XXX	50.216.XXX	50.217.XXX
			220	50.248.XXX	50.249.XXX	50.250.XXX	50.251.XXX	50.252.XXX	50.253.XXX
2500	1300	5	160	50.218.XXX	50.219.XXX	50.220.XXX	50.221.XXX	50.222.XXX	50.223.XXX
			220	50.254.XXX	50.255.XXX	50.256.XXX	50.257.XXX	50.258.XXX	50.259.XXX
2500	1000	6	160	50.224.XXX	50.225.XXX	50.226.XXX	50.227.XXX	50.228.XXX	50.229.XXX
			220	50.260.XXX	50.261.XXX	50.262.XXX	50.263.XXX	50.264.XXX	50.265.XXX
2500	1300	6	160	50.230.XXX	50.231.XXX	50.232.XXX	50.233.XXX	50.234.XXX	50.235.XXX
			220	50.272.XXX	50.273.XXX	50.280.XXX	50.281.XXX	50.288.XXX	50.289.XXX

Dimensions and load capacities

- Max. load per unit 1,000 kg
- Max. compartment load: 80, 160, 220, 280 kg
- Adjustment increment: 25 mm

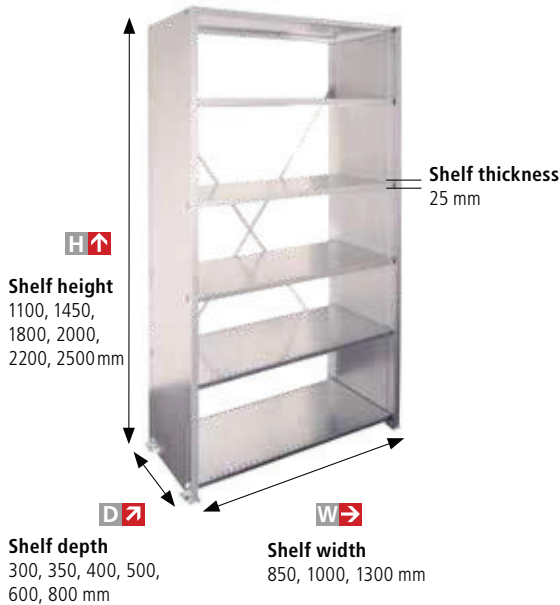

Planning instructions

Calculating the external dimensions

- Overall width of shelving: Total shelf widths + 50 mm (base plate external)
- Overall depth of shelving: Shelf depth + 36 mm

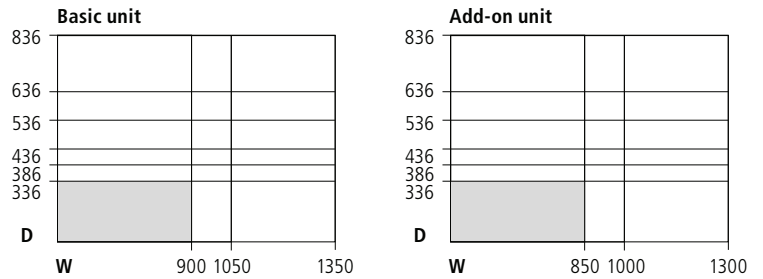

Max. base and extension section per shelving unit

Shelf spacing (mm)	150	300	450	600	max. 750
Permissible section load with diagonals or longitudinal connectors (kg)	max. 800	max. 770	max. 750	max. 710	max. 680
Permissible section load with rear panels (kg)	max. 1050	max. 1000	max. 950	max. 900	max. 850

! The load data apply only for uniformly distributed load! Please observe the safety instructions on page 226.

Basic and add-on shelf units

Compartment load 80 or 160 kg, galvanised or painted

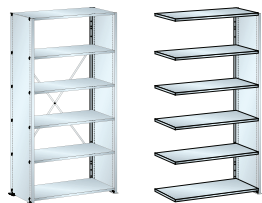

- Basic unit**
2 solid sheet side panels
1 diagonal brace, galvanised
4–7 shelves, plain (thickness 25 mm)
- Add-on unit**
1 solid sheet side panel
4–7 shelves, plain (thickness 25 mm)

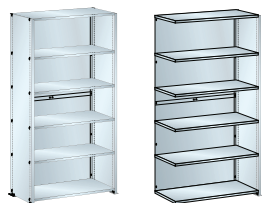

- Basic unit**
2 solid sheet side panels
1 rear panel, plain (2-part)
4–7 shelves, plain (thickness 25 mm)
- Add-on unit**
1 solid sheet side panel
1 rear panel, plain (2-part)
4–7 shelves, plain (thickness 25 mm)



- Basic unit**
2 solid sheet side panels
1 rear panel, plain (2-part)
1 hinged door, lockable
6–7 shelves, plain (thickness 25 mm)
- Add-on unit**
1 solid sheet side panel
1 rear panel, plain (2-part)
1 hinged door, lockable
6–7 shelves, plain (thickness 25 mm)











- Basic unit**
2 solid sheet side panels
1 rear panel, plain (2-part)
7 drawers (3 × 100, 4 × 150 mm)
4 shelves, plain (thickness 25 mm)
- Add-on unit**
1 solid sheet side panel
1 rear panel, plain (2-part)
7 drawers (3 × 100, 4 × 150 mm)
4 shelves, plain (thickness 25 mm)

	Number of shelves	1000 × 350 mm		1000 × 500 mm	
		Compartment load 80 kg		Compartment load 160 kg	
mm		Basic unit	Add-on unit	Basic unit	Add-on unit
1100	4	Art. no. 45.919.XXX	Art. no. 45.928.XXX	-	-
1450	5	Art. no. 45.922.XXX	Art. no. 45.931.XXX	-	-
1800	6	Art. no. 45.925.XXX	Art. no. 45.934.XXX	-	-
2000	6	Art. no. 50.300.XXX	Art. no. 50.301.XXX	Art. no. 50.302.XXX	Art. no. 50.303.XXX
2200	7	Art. no. 50.304.XXX	Art. no. 50.305.XXX	Art. no. 50.306.XXX	Art. no. 50.307.XXX
1100	4	Art. no. 45.955.XXX	Art. no. 45.964.XXX	-	-
1450	5	Art. no. 45.958.XXX	Art. no. 45.967.XXX	-	-
1800	6	Art. no. 45.961.XXX	Art. no. 45.970.XXX	-	-
2000	6	Art. no. 50.308.XXX	Art. no. 50.309.XXX	Art. no. 50.405.XXX	Art. no. 50.406.XXX
2200	7	Art. no. 50.407.XXX	Art. no. 50.408.XXX	Art. no. 50.409.XXX	Art. no. 50.410.XXX
2000	6	Art. no. 50.411.XXX	Art. no. 50.412.XXX	Art. no. 50.413.XXX	Art. no. 50.414.XXX
2200	7	Art. no. 50.415.XXX	Art. no. 50.416.XXX	Art. no. 50.417.XXX	Art. no. 50.418.XXX
2000	4	-	-	Art. no. 50.419.XXX	Art. no. 50.420.XXX
2200	4	-	-	Art. no. 50.421.XXX	Art. no. 50.422.XXX

1a. Pair of shelf supports Max. load per unit, 2,800 kg

Consisting of 2 shelf supports, 2 base plates and 3 horizontal braces (4 horizontal braces for height of 3000 mm). Slots 25 mm apart for attaching shelf supports at any height, including fastening material. Specification: Shelf supports in cold-rolled C profile, 40 x 75 mm, with 6 edge turns for maximum stability. Base plate, galvanised. Without Floor anchoring. Colour: As per colour chart or galvanised.



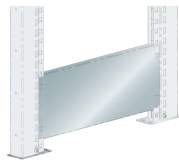

	300	350	400	500	600	800
	Art. no. 	Art. no. 	Art. no. 	Art. no. 	Art. no. 	Art. no. 
1100	45.680.XXX	45.681.XXX	45.682.XXX	46.380.XXX	46.381.XXX	46.382.XXX
1450	45.683.XXX	45.684.XXX	45.685.XXX	46.383.XXX	46.384.XXX	46.385.XXX
1800	45.686.XXX	45.687.XXX	45.688.XXX	45.689.XXX	45.690.XXX	45.691.XXX
2000	50.000.XXX	50.001.XXX	50.002.XXX	50.003.XXX	50.004.XXX	50.005.XXX
2200	50.516.XXX	50.517.XXX	50.518.XXX	50.519.XXX	50.520.XXX	50.521.XXX
2500	50.006.XXX	50.007.XXX	50.008.XXX	50.009.XXX	50.010.XXX	50.011.XXX
3000	45.692.XXX	45.693.XXX	45.694.XXX	45.695.XXX	45.696.XXX	45.697.XXX
Dimensions (W x D) mm	40 x 304	40 x 354	40 x 404	40 x 504	40 x 604	40 x 804



Additional horizontal braces

Specification: Steel sheet. Colour: As per colour chart or galvanised.

Art. no. 	Art. no. 	Art. no. 	Art. no. 	Art. no. 	Art. no. 
45.510.XXX	45.511.XXX	45.512.XXX	45.513.XXX	45.514.XXX	45.515.XXX

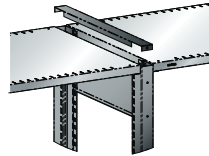

Shelf support cover

For covering the top of shelf supports. Specification: Steel sheet. Colour: As per colour chart or galvanised.

Art. no. 	Art. no. 	Art. no. 	Art. no. 	Art. no. 	Art. no. 
50.510.XXX	50.511.XXX	50.512.XXX	50.513.XXX	50.514.XXX	50.515.XXX



Intermediate fill-in strip

To close off intermediate spaces when shelves are at the same height. Not suitable for use with partitions. Description: sheet steel. Colour: according to colour chart or galvanised.

Art. no. 	Art. no. 	Art. no. 	Art. no. 	Art. no. 	Art. no. 
45.810.XXX	45.811.XXX	45.812.XXX	45.813.XXX	45.814.XXX	45.815.XXX

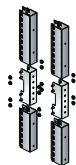

Extension unit, per pair of shelf supports

For shelving heights up to 5 m including fastening material. The static calculations for the extension will be carried out by LISTA's specialists. Specification: Galvanised.

Art. no.
50.484.000

 Levelling plates and floor anchoring on page 229.



1b. Solid sheet side panel **Max. load per unit 1,000 kg**

Standard with triangular folded reinforcing at the front. Slots 25 mm apart for attaching shelf supports. Including base plate set, galvanised. Specification: Steel sheet. Without Floor anchoring. Colour: As per colour chart or galvanised.



! Side panel with T-edging for add-on units with rear panels.

D ↑ H ↑		300	350	400	500	600	800
		Art. no.	Art. no.	Art. no.	Art. no.	Art. no.	Art. no.
1100	Standard	45.607.XXX	45.608.XXX	45.609.XXX	46.386.XXX	46.387.XXX	46.388.XXX
	T-edging	45.637.XXX	45.638.XXX	45.639.XXX	46.395.XXX	46.396.XXX	46.397.XXX
1450	Standard	45.610.XXX	45.611.XXX	45.612.XXX	46.389.XXX	46.390.XXX	46.391.XXX
	T-edging	45.640.XXX	45.641.XXX	45.642.XXX	46.398.XXX	46.399.XXX	46.400.XXX
1800	Standard	45.613.XXX	45.614.XXX	45.615.XXX	46.392.XXX	46.393.XXX	46.394.XXX
	T-edging	45.643.XXX	45.644.XXX	45.645.XXX	46.401.XXX	46.402.XXX	46.403.XXX
2000	Standard	50.193.XXX	50.194.XXX	50.195.XXX	50.196.XXX	50.197.XXX	50.198.XXX
	T-edging	50.534.XXX	50.535.XXX	50.536.XXX	50.537.XXX	50.538.XXX	50.539.XXX
2200	Standard	50.522.XXX	50.523.XXX	50.524.XXX	50.525.XXX	50.526.XXX	50.527.XXX
	T-edging	50.540.XXX	50.541.XXX	50.542.XXX	50.543.XXX	50.544.XXX	50.545.XXX
2500	Standard	50.528.XXX	50.529.XXX	50.530.XXX	50.531.XXX	50.532.XXX	50.533.XXX
	T-edging	50.546.XXX	50.547.XXX	50.548.XXX	50.549.XXX	50.550.XXX	50.024.XXX
Dimensions (W × D) mm		30 × 336	30 × 386	30 × 436	30 × 536	30 × 636	30 × 836

! **NEW!**
Shelf heights 1,100mm, 1,450mm and 1,800mm for 3, 4 or 5 file heights

! **Adapter side panel with T-edging** for combining depth 350 with 500 mm including 2 shelf supports

D ↑ H ↑	500	
	Art. no.	
2000	50.032.XXX	
2200	50.033.XXX	
2500	50.034.XXX	
Dimensions (W × D) mm		30 × 536

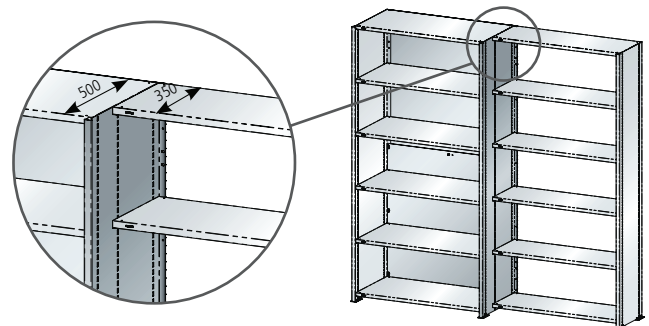

Shelf supports for additional shelves

For the adapter side panel with T-edge, special shelf supports are required if shelves at the same height are used next to one another. Two of these are required for each shelf.

Art. no. **45.739.000**
10 pieces

Levelling plates, 50 × 100 mm

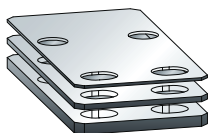
To compensate for height. Enable units to be aligned with precision on uneven floors. Specification: PVC. Colour: Grey.



Art. no.	Thickness 1 mm	Thickness 2 mm	Thickness 4 mm
	50.481.000	50.482.000	50.483.000

Floor anchoring

Please follow the assembly instructions provided. For single shelf units, 2 per side panel or 2 per pair of shelf supports.

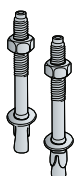

Floor anchor Art. no. **50.299.000**
M8 × 80, each

! Please observe the safety instructions on page 226.



Shelving systems | Universal shelving L1006, single components



Side panel cover, plain or perforated

Add-on panel for covering the shelf supports or the rows of slots in the solid sheet side panels. Can be attached left or right. For perforated side panel cover: 10 × 10 mm square holes and 38 mm divisions for holding keyhole hooks. Specification: Steel sheet, 2-part for height 3000 mm (1000 + 2000 mm). Colour: As per colour chart or galvanised.

		300	350	400	500	600	800
		Art. no.	Art. no.	Art. no.	Art. no.	Art. no.	Art. no.
1100	Plain	45.616.XXX	45.617.XXX	45.618.XXX	46.404.XXX	46.405.XXX	46.406.XXX
	Plain, per pair*	-	45.890.XXX	45.894.XXX	-	-	-
1450	Plain	45.619.XXX	45.620.XXX	45.621.XXX	46.407.XXX	46.408.XXX	46.409.XXX
	Plain, per pair*	-	45.891.XXX	45.895.XXX	-	-	-
1800	Plain	45.622.XXX	45.623.XXX	45.624.XXX	45.646.XXX	45.647.XXX	45.648.XXX
	Plain, per pair*	-	45.892.XXX	45.896.XXX	-	-	-
2000	Plain	50.012.XXX	50.013.XXX	50.014.XXX	50.015.XXX	50.016.XXX	50.017.XXX
	Plain, per pair*	-	45.893.XXX	45.897.XXX	-	-	-
	Perforated	50.337.XXX	50.338.XXX	50.339.XXX	50.340.XXX	50.341.XXX	50.342.XXX
2200	Plain	50.331.XXX	50.332.XXX	50.333.XXX	50.334.XXX	50.335.XXX	50.336.XXX
	Perforated	50.343.XXX	50.344.XXX	50.345.XXX	50.346.XXX	50.347.XXX	50.348.XXX
2500	Plain	50.018.XXX	50.019.XXX	50.020.XXX	50.021.XXX	50.022.XXX	50.023.XXX
	Perforated	50.349.XXX	50.350.XXX	50.351.XXX	50.352.XXX	50.353.XXX	50.354.XXX
3000	Plain	45.820.XXX	45.821.XXX	45.822.XXX	45.823.XXX	45.824.XXX	45.825.XXX
	Perforated	45.826.XXX	45.827.XXX	45.828.XXX	45.829.XXX	45.830.XXX	45.831.XXX
Dimensions (W) mm		21	21	21	21	21	21

*Filler panels (left and right) for covering the rows of slots in the side panels and for flush closure with the front triangular edging of the side panels.

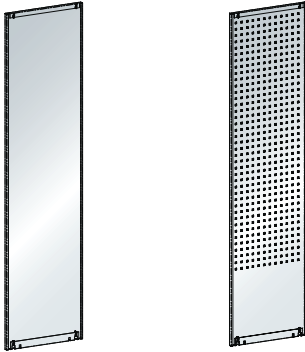

Grating cover, side panel cover or partition (plain) for shelf supports

Side panel grating cover: The gratings are clamped in place by the shelf supports and shelves. Can also be used as partition. Specification: Steel wire 3.0 mm, mesh size 50 × 50 mm, galvanised, blue chromated according to DIN 50961.

Partition (plain): Is placed between the shelf supports and held in place by the shelves. Specification: Steel sheet, 2-part for height 3000 mm (1000 + 2000 mm). Colour: As per colour chart or galvanised.

		300	350	400	500	600	800
		Art. no.	Art. no.	Art. no.	Art. no.	Art. no.	Art. no.
2000	Grating	50.387.000	50.388.000	50.389.000	50.390.000	50.391.000	50.392.000
	Plain	50.375.XXX	50.376.XXX	50.310.XXX	50.311.XXX	50.312.XXX	50.377.XXX
2200	Grating	50.393.000	50.394.000	50.395.000	50.396.000	50.397.000	50.398.000
	Plain	50.378.XXX	50.379.XXX	50.380.XXX	50.381.XXX	50.382.XXX	50.383.XXX
2500	Grating	50.399.000	50.400.000	50.401.000	50.402.000	50.403.000	50.404.000
	Plain	50.384.XXX	50.385.XXX	50.313.XXX	50.314.XXX	50.315.XXX	50.386.XXX
3000	Grating	45.832.000	45.833.000	45.834.000	45.835.000	45.836.000	45.837.000
	Plain	45.838.XXX	45.839.XXX	45.840.XXX	45.841.XXX	45.842.XXX	45.843.XXX
Dimensions (W) mm		3	3	3	3	3	3

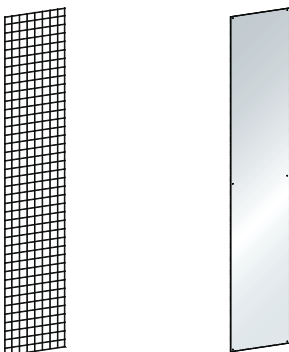

Base covers

Protects against dust and dirt. The base covers rest on the base plates and are hooked into the shelf supports or side panels by shelf supports. Including fastening material. Specification: Steel sheet. Colour: as per colour chart, **not available in galvanised version.**

		850	1000	1300
		Art. no.	Art. no.	Art. no.
25 mm		50.432.XXX	50.433.XXX	50.434.XXX



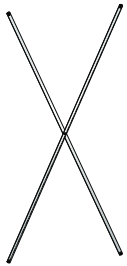

2. Diagonal brace

For stabilising the shelving units lengthwise. Fastening material included. Specification: Steel, galvanised.

Diagonal brace arrangement:

For each basic unit and for every third add-on unit, an extra diagonal brace is required.

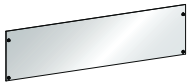

Lengthwise braces

Instead of diagonal braces, lengthwise braces (at the top and bottom) can be used in order to make the unit accessible from both sides.

Including fastening material.

Specification: Steel sheet.

Colour: As per colour chart or galvanised.

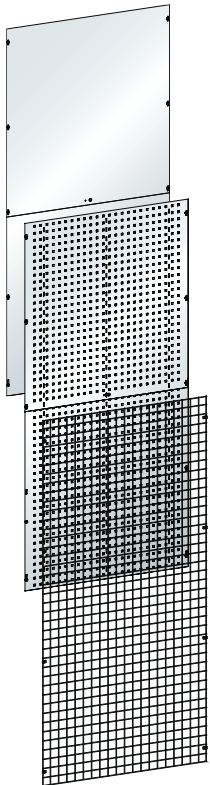

Rear panels, plain or perforated

The rear panel cover for shelving sections also stabilises the units lengthwise and is screwed to the shelf supports or side panels.

For perforated rear panel: Specification: 10 × 10 mm square holes and 38 mm divisions for holding keyhole hooks (see page 163). Including fastening material.

Specification: 2-part, sheet steel.

Colour: As per colour chart or galvanised.

Rear grating

Rear grating filling for shelf units. The rear gratings are screwed to the shelf supports or side panels. Including fastening material. Specification: Steel wire 3.0 mm.

Mesh size 50 × 50 mm, galvanised, blue chromated according to DIN 50961.

! To stabilise the shelving systems lengthwise, diagonal or lengthwise braces must be used in addition to the perforated rear panel.

! **Rear panel link piece** is absolutely essential for all rear panels used in combination with shelf supports. Basic unit: 2 × width 80 mm and for each add-on unit 1 × width 120 mm. Specification: Steel sheet. Colour: As per colour chart or galvanised.



H ↑	W →	Model	Art. no.
1100–1450	850–1000	for shelf supports and solid sheet side panel	45.655.000
1100–1450	1300	for shelf supports	327.795.000
1100–1450	1300	for solid sheet side panel	344.289.000
1800–2500	850–1300	for shelf supports and solid sheet side panel	50.026.000
3000	850–1300	for shelf supports and solid sheet side panel	45.844.000

W →	850	1000	1300
version	Art. no.	Art. no.	Art. no.
For shelf supports, per pair, height 185 mm	50.319.XXX	50.320.XXX	50.321.XXX
For solid sheet side panel, per pair, height 185 mm	50.322.XXX	50.323.XXX	50.324.XXX

W →	850	1000	1300
H ↑	Art. no.	Art. no.	Art. no.
1100 Plain	45.600.XXX	45.601.XXX	46.410.XXX
1450 Plain	45.602.XXX	45.603.XXX	46.411.XXX
1800 Plain	45.604.XXX	45.605.XXX	45.606.XXX
2000 Plain	50.355.XXX	50.027.XXX	50.029.XXX
Perforated	50.360.XXX	50.361.XXX	50.362.XXX
Grating	50.423.000	50.424.000	50.425.000
2200 Plain	50.356.XXX	50.357.XXX	50.358.XXX
Perforated	50.363.XXX	50.364.XXX	50.365.XXX
Grating	50.426.000	50.427.000	50.428.000
2500 Plain	50.359.XXX	50.028.XXX	50.030.XXX
Perforated	50.366.XXX	50.367.XXX	50.368.XXX
Grating	50.429.000	50.430.000	50.431.000
3000 Plain	45.845.XXX	45.846.XXX	45.847.XXX
Perforated	45.848.XXX	45.849.XXX	45.850.XXX
Grating	45.851.000	45.852.000	45.853.000

W →	80	120
H ↑	Art. no.	Art. no.
1100	45.649.XXX	45.650.XXX
1450	45.651.XXX	45.652.XXX
1800	45.653.XXX	45.654.XXX
2000	50.369.XXX	50.370.XXX
2200	50.371.XXX	50.372XXX
2500	50.373.XXX	50.374.XXX
3000	45.854.XXX	45.855.XXX









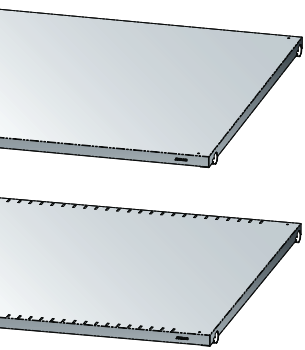



Shelving systems | Universal shelving L1006, single components

3 Shelves, plain or slotted Max. compartment load 80, 160, 220, 280 and 350 kg

Including floor anchor. Shelf thickness 25 mm. Specification: Steel sheet. Colour: As per colour chart or galvanised.



				300	350	400	500	600	800	
	Shelf load 			Art. no. 	Art. no. 	Art. no. 	Art. no. 	Art. no. 	Art. no. 	
850	80	Plain		50.035.XXX	50.036.XXX	50.038.XXX	-	-	-	
		Slotted		50.080.XXX	50.081.XXX	50.083.XXX	-	-	-	
	160	Plain		55.737.XXX	50.037.XXX	50.039.XXX	50.041.XXX	50.044.XXX	50.047.XXX	
		Slotted		55.738.XXX	50.082.XXX	50.084.XXX	50.086.XXX	50.089.XXX	50.092.XXX	
	220	Plain		-	-	50.040.XXX	50.042.XXX	50.045.XXX	50.048.XXX	
		Slotted		-	-	50.085.XXX	50.087.XXX	50.090.XXX	50.096.XXX	
280	Plain		-	-	-	50.043.XXX	50.046.XXX	50.049.XXX		
	Slotted		-	-	-	50.088.XXX	50.091.XXX	50.097.XXX		
1000	80	Plain		50.050.XXX	50.051.XXX	50.053.XXX	-	-	-	
		Slotted		50.098.XXX	50.164.XXX	50.166.XXX	-	-	-	
	160	Plain		55.739.XXX	50.052.XXX	50.054.XXX	50.056.XXX	50.059.XXX	50.062.XXX	
		Slotted		55.741.XXX	50.165.XXX	50.167.XXX	50.169.XXX	50.172.XXX	50.175.XXX	
	220	Plain		-	-	50.055.XXX	50.057.XXX	50.060.XXX	50.063.XXX	
		Slotted		-	-	50.168.XXX	50.170.XXX	50.173.XXX	50.176.XXX	
	280	Plain		-	-	-	50.058.XXX	50.061.XXX	50.064.XXX	
		Slotted		-	-	-	50.171.XXX	50.174.XXX	50.177.XXX	
	350	Plain		-	-	-	45.550.XXX	45.551.XXX	45.552.XXX	
		Slotted		-	-	-	45.556.XXX	45.557.XXX	45.558.XXX	
	1300	80	Plain		50.065.XXX	50.066.XXX	50.068.XXX	-	-	-
			Slotted		50.178.XXX	50.179.XXX	50.181.XXX	-	-	-
160		Plain		55.746.XXX	50.067.XXX	50.069.XXX	50.071.XXX	50.074.XXX	50.077.XXX	
		Slotted		55.747.XXX	50.180.XXX	50.182.XXX	50.184.XXX	50.187.XXX	50.190.XXX	
220		Plain		-	-	50.070.XXX	50.072.XXX	50.075.XXX	50.078.XXX	
		Slotted		-	-	50.183.XXX	50.185.XXX	50.188.XXX	50.191.XXX	
280		Plain		-	-	-	50.073.XXX	50.076.XXX	50.079.XXX	
		Slotted		-	-	-	50.186.XXX	50.189.XXX	50.192.XXX	



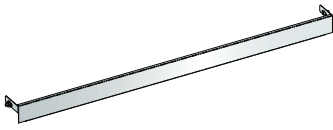

Stop bars for sloping shelves

The stop bars can be screwed front and back to the shelf supports or side panels. The shelves and stop bars can also be slotted in at an angle. Ideal for making material and parts available according to the FIFO principle. Specification: Steel sheet. Colour: As per colour chart or galvanised.

W →	850	1000	1300
Art. no.	Art. no.	Art. no.	Art. no.
	50.316.XXX	50.317.XXX	50.318.XXX

Max. angle of inclination of the shelves:

Depth 300 = 33°, 350 = 29°, 400 = 28°, 500 = 25°, 600 = 23°, 800 = 20°



Shelf labelling

Self-adhesive plastic label strips with hinged transparent protector, including labels. Width × height, 210 × 22 mm.

Sales units	Art. no.
10 pieces	18.931.000

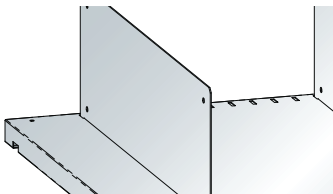

Dividers

For subdividing slotted shelves. Specification: Steel sheet. Colour: As per colour chart or galvanised. **Sales unit: 10 pcs.**

D ↗	300	350	400	500	600	800
H ↑	Art. no.	Art. no.	Art. no.	Art. no.	Art. no.	Art. no.
100	50.103.XXX	50.106.XXX	50.109.XXX	50.112.XXX	50.115.XXX	50.118.XXX
150	50.104.XXX	50.107.XXX	50.110.XXX	50.113.XXX	50.116.XXX	50.119.XXX
200	50.105.XXX	50.108.XXX	50.111.XXX	50.114.XXX	50.117.XXX	50.120.XXX

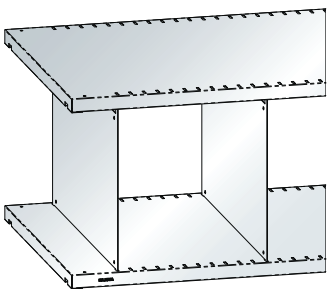

Shelf dividers

For subdividing slotted shelves. The height of the shelf dividers, slotted in at the top and the bottom, depends on the distance between the shelves. Clear shelf spacing = shelf divider height. Specification: Steel sheet. Colour: As per colour chart or galvanised. **Sales unit: 10 pcs.**

D ↗	300	350	400	500	600	800
H ↑	Art. no.	Art. no.	Art. no.	Art. no.	Art. no.	Art. no.
250	50.121.XXX	50.126.XXX	50.131.XXX	50.136.XXX	50.141.XXX	50.146.XXX
300	50.122.XXX	50.127.XXX	50.132.XXX	50.137.XXX	50.142.XXX	50.147.XXX
325	50.123.XXX	50.128.XXX	50.133.XXX	50.138.XXX	50.143.XXX	50.148.XXX
350	50.124.XXX	50.129.XXX	50.134.XXX	50.139.XXX	50.144.XXX	50.149.XXX
400	50.125.XXX	50.130.XXX	50.135.XXX	50.140.XXX	50.145.XXX	50.150.XXX



Shelving systems | Universal shelving L1006, single components

4. Shelf front cover strip

For storing bulk goods and small parts. Is screwed to the shelf supports or side panels. Including fastening material. Specification: Steel sheet. Colour: As per colour chart or galvanised.



	W →	850	1000	1300
H ↑		Art. no. 🌈	Art. no. 🌈	Art. no. 🌈
75		50.435.XXX	50.436.XXX	50.437.XXX



Drawers

Smooth-running drawers with full extension for ideal storage of small parts and tools. Load capacity 50 kg. Specification: Steel sheet. Colour: As per colour chart, **not available in galvanised version**.

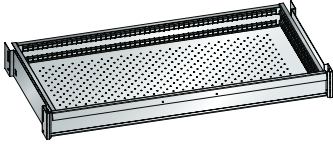

	W →	D ↗	1000 × 350	1000 × 500
H ↑			Art. no. 🌈	Art. no. 🌈
75			55.165.XXX	55.172.XXX
100			55.166.XXX	55.173.XXX
150			55.167.XXX	55.174.XXX
LISTA units			54 × 18 E	54 × 27 E
Useable drawer size (W × D mm)			918 × 306	918 × 459



Drip trays

Can be placed loose on the shelves with a shelf width of 1,000 mm. Can also be removed if hinged doors are used. Specification: Height 100 mm, chromium steel. Material thickness: 2 mm. Welded liquid-tight. Designed according to Section 19 WHG (German Water Resources Act) / StawaR (German directive on steel trays). The drip tray is leak-tested and has a data plate to that effect as well as a test certificate.



	W →	300	350	400	500	600	800
H ↑		Art. no.	Art. no.	Art. no.	Art. no.	Art. no.	Art. no.
1000		53.823.000	53.828.000	53.824.000	53.825.000	53.826.000	53.827.000
Capacity in litres		26	32	36	45	54	72

Pull-out shelf

Load capacity 50 kg. Model: sheet steel. Colour: as per colour chart, **not available in galvanised version**.

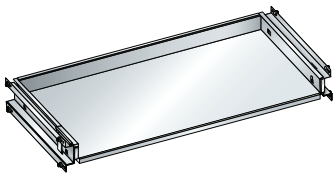

	W →	850	1000	1300
H ↑		757	907	1207
D ↗		Art. no. 🌈	Art. no. 🌈	Art. no. 🌈
350	332	46.370.XXX	46.371.XXX	46.372.XXX
400	382	46.373.XXX	46.374.XXX	46.375.XXX
500	482	46.376.XXX	46.377.XXX	46.378.XXX



Pull-out suspension filing frame

Suitable for A4 suspension files. Max. load capacity 50 kg. Specification: Steel sheet. Colour: As per colour chart, **not available in galvanised version**.

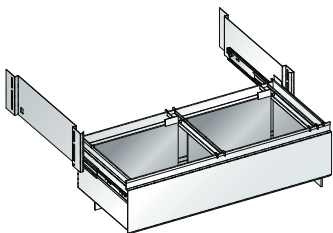

	W →	850	1000	1300
D ↗		Art. no. 🌈	Art. no. 🌈	Art. no. 🌈
350		50.441.XXX	50.444.XXX	50.446.XXX
400		50.442.XXX	50.445.XXX	50.447.XXX
500		50.443.XXX	50.156.XXX	50.448.XXX



Lateral profiles

C700.16 for storage system: Vetro lateral file A4 landscape (985 × 450 A4 lateral and folio)

C700.17 for storage system: Datox EDP files, Monopendex files, ELBA centre point suspension files 91460, Leitz suspension files, Eichner suspension files. Specification: Steel sheet. Colour: Grey, NCS S 2502-R. Including fastening material.

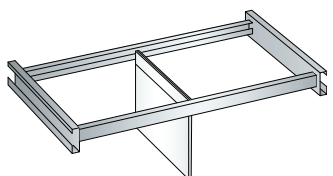

		W →	850	1000	1300
D ↗	version		Art. no.	Art. no.	Art. no.
350	C700.16		35.143.000	32.559.000	50.154.000
	C700.17		35.149.000	32.581.000	50.157.000
500	C700.16		35.147.000	32.578.000	50.155.000
	C700.17		35.153.000	32.599.000	50.158.000

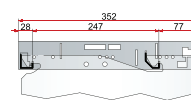

C700.16

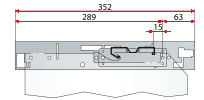

C700.17





Centre partition

For vertically subdividing complete shelf units with a depth of 500 mm. The centre divider is fixed in place by the shelves. Width 30 mm. Height of centre divider = shelf unit height - 25 mm. Specification: Steel sheet. Colour: As per colour chart or galvanised.

	H ↑	2000	2200	2500
D ↗		Art. no.	Art. no.	Art. no.
500		50.328.XXX	50.329.XXX	50.330.XXX

! Select the top shelf so that it fits over the entire width of the shelving unit. Further assembly of the shelving units takes place with shelves for the centre partition.

Plain shelves, smooth, for centre divider

Including floor anchor. Shelf thickness 25 mm. Unit load 80 kg. Specification: Steel sheet. Colour: As per colour chart or galvanised.

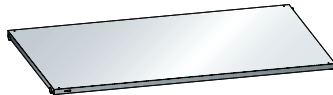

	W →	425	500	650
D ↗		Art. no.	Art. no.	Art. no.
500		50.325.XXX	50.326.XXX	50.327.XXX

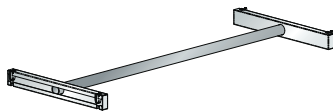

Clothes rail for centre divider

The clothes rails are fitted by means of crossbar plates and shelf supports. Specification: Rail made of anodised aluminium, Ø 27 mm, crossbars in sheet steel. Load capacity 50 kg. Colour of the crossbars: As per colour chart or galvanised.

	W →	425	500	650
D ↗		Art. no.	Art. no.	Art. no.
500		50.495.XXX	50.496.XXX	50.497.XXX

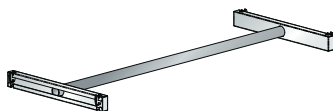

Clothes rail

The clothes rails are fitted by means of crossbar plates and shelf supports. Specification: Rail made of anodised aluminium, Ø 27 mm, crossbars in sheet steel. Load capacity 50 kg. Colour of the crossbars: As per colour chart or galvanised.

	W →	850	1000	1300
D ↗		Art. no.	Art. no.	Art. no.
400		50.498.XXX	50.502.XXX	50.506.XXX
500		50.499.XXX	50.503.XXX	50.507.XXX
600		50.500.XXX	50.504.XXX	50.508.XXX
800		50.501.XXX	50.505.XXX	50.509.XXX

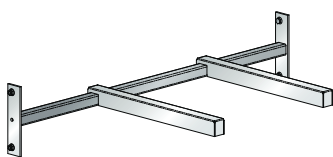

Organising rail

For vertical storage, compartment division and for storing various materials in rings (cables, vee belts and tubing). The crossbars are screwed to the shelf supports or side panels. Load capacity 50 kg. The brackets are screwed to the crossbar. Including fastening material. Specification: Steel sheet. Colour: As per colour chart, **not available in galvanised version**.

Crossbars

	W →	850	1000	1300
		Art. no.	Art. no.	Art. no.
		50.486.XXX	50.487.XXX	50.488.XXX



Brackets

	D ↗	300	350	400	500	600	800
		Art. no.	Art. no.	Art. no.	Art. no.	Art. no.	Art. no.
		50.489.XXX	50.490.XXX	50.491.XXX	50.492.XXX	50.493.XXX	50.494.XXX



Pair of tyre shelf levels

Screwed together with the shelf supports. Model: sheet steel, galvanised.

W →	Shelf load kg	Model	Cod. art
1000	160	per pair	46.028.222
1300	160	per pair	46.029.222



5. Hinged doors

Hinged with a 2-point bar lock with a recess for a clasp lock (must be ordered separately). The hinged doors can also be retrofitted to all shelf units. Specification: Steel sheet. Colour: As per colour chart, **not available in galvanised version**.
Shelving depth with hinged door = shelving depth side panel/pair of shelf supports +30 mm



H ↑ W →	Shelf supports			Side panel		
	850	1000	1300	850	1000	1300
1100	Art. no. 46.412.XXX	Art. no. 46.413.XXX	Art. no. 46.414.XXX	Art. no. 45.631.XXX	Art. no. 45.632.XXX	Art. no. 46.421.XXX
1450	46.415.XXX	46.416.XXX	46.417.XXX	45.633.XXX	45.634.XXX	46.422.XXX
1800	46.418.XXX	46.419.XXX	46.420.XXX	45.635.XXX	45.636.XXX	46.423.XXX
2000	50.472.XXX	50.473.XXX	50.474.XXX	50.467.XXX	50.160.XXX	50.162.XXX
2200	50.475.XXX	50.476.XXX	50.477.XXX	50.468.XXX	50.469.XXX	50.470.XXX
2500	50.478.XXX	50.479.XXX	50.480.XXX	50.471.XXX	50.161.XXX	50.163.XXX



Cover profile with supports

Basic unit: 2 x cover profile and for each add-on unit 1 x cover profile. Specification: sheet steel. Colour: As per colour chart, **not available in galvanised version**.

! Cover profile for hinged doors is absolutely essential for all hinged doors used in combination with shelf supports.

H ↑	1100	1450	1800	2000	2200	2500
Art. no.	46.424.XXX	46.425.XXX	46.426.XXX	45.740.XXX	45.741.XXX	45.742.XXX

+ Clasp lock

KEY Lock, separately lockable	49.060.000
CODE Lock	49.085.000
RFID Lock	49.086.000



+ Clasp lock cover (optional)

Rear clasp lock cover for a more attractive appearance. **45.868.XXX**
 Specification: sheet steel. Colour: As per colour chart.

Sliding doors

Two shelving sections are closed with each sliding door. Running smoothly and quietly on castors: In a runner and guide rail which are fastened to the shelf supports at the bottom and/or at the top. Lockable with a lock-down cylinder lock. **The lock must be ordered separately**. The doors can be opened wide enough for one entire shelving unit to be freely accessible. The sliding doors can also be fitted later. Specification: Steel sheet. Colour: As per colour chart, **not available in galvanised version**. **Shelving depth with hinged door = shelving depth side panel/pair of shelf supports +105 mm**



H ↑ W →	Shelf supports			Side panel		
	2 x 850	2 x 1000	2 x 1300	2 x 850	2 x 1000	2 x 1300
2000	Art. no. 50.458.XXX	Art. no. 50.459.XXX	Art. no. 50.460.XXX	Art. no. 50.449.XXX	Art. no. 50.450.XXX	Art. no. 50.451.XXX
2200	50.461.XXX	50.462.XXX	50.463.XXX	50.452.XXX	50.453.XXX	50.454.XXX
2500	50.464.XXX	50.465.XXX	50.466.XXX	50.455.XXX	50.456.XXX	50.457.XXX

+ Lock-down cylinder lock

KEY Lock, separately lockable	55.438.000
-------------------------------	------------



6. Add-on elements for "Office"

Sideboard

Equipment: with optional multiplex or resin cover panel. Side panels, side panel covers (right and left) for covering the rows of slots and for flush closure with the front triangular edging, rear panel cover for shelving units and lengthwise stability. 3–4 shelves, slotted (thickness 25 mm) per shelf bay Description: sheet steel. Colour: according to colour chart or galvanised.



D	Actual depth mm	H	Number shelves	Actual height mm	Actual width mm	Actual width mm	
						1000	2 x 1000
350	395	1100	3	1132		Art. no.	Art. no.
				1124		45.975.XXX	45.976.XXX
		1450	4	1482		45.977.XXX	45.978.XXX
				1474		45.979.XXX	45.980.XXX
400	445	1100	3	1132		45.981.XXX	45.982.XXX
				1124		45.983.XXX	45.984.XXX
		1450	4	1482		45.985.XXX	45.986.XXX
				1474		45.987.XXX	45.988.XXX
Shelf load (kg)						80	80



Cover panel, resin-coated, thickness 22 mm

Surface and edging light grey, NCS S 1500-N, laminated chipboard (quality class E1), with melamine coating on both sides (manufactured according to standard EN 14322). 2 mm thick plastic edging on all sides. Including double-sided adhesive tape.



Multiplex cover panel, thickness 30 mm

Made of steamed beech veneers, glued in multiple layers and waterproof (DIN 68 705), bevelled edges, sanded, oiled and waxed surface. The panel is splash-proof, dirt-repellent and largely impervious to oil and grease. Including double-sided adhesive tape.



Shelving systems | Heavy-duty pull-out shelving systems

Heavy-duty pull-out shelving systems are ideal for the safe and convenient storage of heavy items such as injection moulds, punching tools, electric motors and pallet goods. Since they can be loaded using lifting gear, they can be installed in a compact arrangement. Load capacities of up to 9000 kg per unit and the availability of different shelving heights, shelf depths and unit widths and the wide selection of equipment options mean that they can be adapted to perfectly suit any type of storage item.





+ Utmost stability
through robust, solid design with a very high load capacity of up to 9 t per shelving unit

+ Optimum use of space
with shelving heights of up to 2.50 m for perfectly organised storage of very heavy inventory items

+ High load capacities
up to 200 kg per top shelf, up to 1000 kg per fixed and pull-out frame

+ Secure locking
with smooth-running roller shutters in combination with side and rear panels

+ Can be adapted to new storage items at any time – through the flexible integration and rearrangement of fixed and pull-out frames in increments of 100 mm

+ Extremely smooth running
through smooth-running pull-outs with stops in closed and fully extendable positions

+ Optimum order and organisation
pallets can be stored lengthwise or crosswise in fixed and pull-out frames

+ Safe and orderly storage
flush storage achieved by placing sheet metal covers on top or inserting chipboard inserts

Dimensions and load capacities

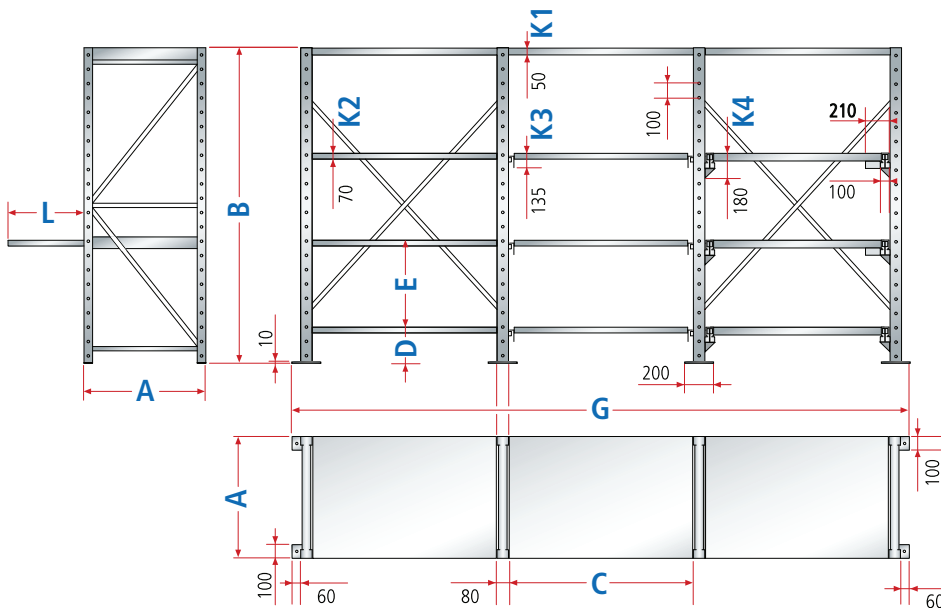

A = Shelving depth
B = Shelving height
C = Shelving width

D = Minimum distance from floor
E = Minimum distance top edge to top edge

G = Number of installation widths + number of side frame widths 80 mm + external base plate widths 60 mm
 Example: $G = 3 \times 1090 \text{ mm} + 4 \times 80 \text{ mm} + 2 \times 60 \text{ mm} = 3710 \text{ mm}$
K1...K4 = Installation heights

Lengthwise pallet storage

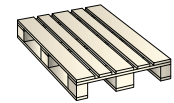

Pallet type	Width mm	Depth mm	Height mm
I	800	1200	150

Crosswise pallet storage

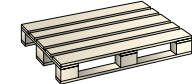

Pallet type	Width mm	Depth mm	Height mm
I	800	1200	150
II	1200	800	150
III	1200	1000	150
IIII	1000	800	150

Shelving depths (A)

D Installed dimensions mm	860	1060	1260
Extension depths (L) mm			
Part extension, 65% extension	510	650	810
Full extension, ~ 100% extension	790	990	1190

Shelf widths (C)

W Installed dimensions mm	890	1090	1290
Side frame width	80	80	80
Base plate width	200	200	200

Load capacities

D Installed dimensions mm	860	1060	1260
Number of pull-out frames			
Fixed frame Number			
		Max. load capacity per pull-out or fixed frame kg	
1 to 5	-	1000	900
1 to 6	-	900	900
1 to 7	-	800	800
1 to 8	-	700	700
1 to 9	-	600	600
-	1 to 9	1000	900
1 to 3	1 to 6	1000	900
1 to 5	1 to 4	800	800
Max. load capacity per top shelf kg		200	150

The maximum load capacities specified must not be exceeded. The load capacities apply only to an evenly distributed load. The maximum load capacity per shelving unit is 9000 kg. **Only one pull-out frame per shelving unit may be pulled out.**

Shelving heights (B)

H Nominal dimensions mm	1500	2000	2200	2500
Installation heights (K)				
Top shelf	K1	50 mm		
Fixed frame	K2	70 mm		
Part extension frame	K3	135 mm		
Full extension frame	K4	180 mm		

Vertical installation distances

Distance from floor (D) minimum	105 mm for fixed frame 165 mm for part extension frame 215 mm for full extension frame
Minimum distance (E) top edge to top edge	100 mm for fixed frame 200 mm for full extension and part extension frame 300 mm for full extension frame with sheet metal cover
Hole spacing	every 100 mm

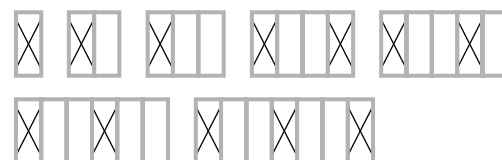

Diagonal brace arrangement

the load capacities only apply when, for 6 shelf units or more, 2 shelf units or at least every fifth shelf unit is fitted with rear panels or 1 diagonal brace per 3 units.

! Anchoring rule

Heavy-duty pull-out shelving units must always be anchored.

+ Optimum use of space for very heavy storage items



Pallet storage

- space-saving pallet storage with a load capacity of up to 1000 kg in fixed frames

Heavy-duty pull-out shelving systems 9000, disassembled

With 2 pull-out frames for part extension (PE, 65% extension) and 1 fixed frame as top shelf, each including chipboard inserts, 40 mm thick. Can be fitted with side panels, further pull-out and fixed frames, metal covers, sliding doors, roller shutters and column guard. Basic unit including 1 diagonal brace for lengthwise stability, 2 side frames, floor anchor and levelling plate set. Add-on unit including 1 side frame, floor anchor and levelling plate set. Hole spacing in the side frame every 100 mm. Specification: steel sheet. Colour: as per colour chart.

Note: from the third add-on unit, an **additional diagonal brace** is required (see p. 242).

H **2000 mm**

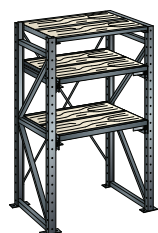

		Pull-out frames	Fixed frames	Shelf load kg	Max. load per unit kg	Basic unit Art. no.	Add-on unit Art. no.
860	890	2	1	1000	9000	71.530.XXX	71.534.XXX
860	1290	2	1	1000	9000	71.532.XXX	71.536.XXX



1260	890	2	1	800	9000	71.531.XXX	71.535.XXX
1260	1290	2	1	800	9000	71.533.XXX	71.537.XXX



Heavy-duty pull-out shelves up to 1000 kg

- for storing large, heavy single items and equipment
- flush storage achieved by placing sheet metal covers on top or inserting chipboard inserts





! Side frames

Side frames are perforated at intervals of 100 mm to allow installation of top shelves, fixed and pull-out frames. Front and back columns are welded together with horizontal and diagonal braces to form a rigid frame. Specification: sheet steel pressed profiles. Colour: as per colour chart.

Caution: four floor anchors are required per side frame.

Side frame cover

For covering the top of the side frames. Specification: sheet steel. Colour: according to colour chart.



Side panels

The side panels and the side frame columns are screwed together. The standard side panels are used for the roller shutter structure. Includes screw fixtures. Specification: sheet steel 1.5 mm. Colour: according to colour chart.



! Side frame connections

Screwed to the side frames at the front and rear. Including screw fasteners. Specification: flat steel. Colour: as per colour chart.



! Diagonal braces

Used instead of rear panels to stabilise units lengthwise. Including screw fasteners. Specification: Steel, galvanised. Number of diagonal braces: see planning notes p. 240.

or...

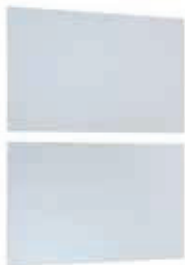

! Rear panels

The rear panel cover for shelving sections also stabilises the units lengthwise and is screwed to the side frames with the columns. Including fastening material. Specification: steel sheet. Colour: as per colour chart.

Installed dimensions mm



860

1060

1260

Side frames



Art. no.

Art. no.

Art. no.

1500

80

73.000.XXX

73.010.XXX

73.020.XXX

2000

80

73.001.XXX

73.011.XXX

73.021.XXX

2200

80

73.002.XXX

73.012.XXX

73.022.XXX

2500

80

73.003.XXX

73.013.XXX

73.023.XXX

for shelving depth mm



860

1060

1260

Side frame cover

Art. no.

Art. no.

Art. no.

73.590.XXX

73.591.XXX

73.592.XXX

for shelving depth mm



860

1060

1260

Side panels



Art. no.

Art. no.

Art. no.

1500

73.500.XXX

73.510.XXX

73.520.XXX

2000

73.501.XXX

73.511.XXX

73.521.XXX

2200

73.502.XXX

73.512.XXX

73.522.XXX

2500

73.503.XXX

73.513.XXX

73.523.XXX

Installed dimensions mm



890

1090

1290

Side frame connections

Art. no.

Art. no.

Art. no.

Per pair

73.060.XXX

73.061.XXX

73.062.XXX

Diagonal braces



Art. no.

Art. no.

Art. no.

1500

73.100.000

73.110.000

73.120.000

2000

73.101.000

73.111.000

73.121.000

2200

73.102.000

73.112.000

73.122.000

2500

73.103.000

73.113.000

73.123.000

Rear panels



Art. no.

Art. no.

Art. no.

1500

73.530.XXX

73.540.XXX

73.550.XXX

Number of parts/dimensions mm

1 × 1000, 1 × 500

1 × 1000, 1 × 500

1 × 1000, 1 × 500

2000

73.531.XXX

73.541.XXX

73.551.XXX

Number of parts/dimensions mm

2 × 1000

2 × 1000

2 × 1000

2200

73.532.XXX

73.542.XXX

73.552.XXX

Number of parts/dimensions mm

1 × 1000, 2 × 600

1 × 1000, 2 × 600

1 × 1000, 2 × 600

2500

73.533.XXX

73.543.XXX

73.553.XXX

Number of parts/dimensions mm

2 × 1000, 1 × 500

2 × 1000, 1 × 500

2 × 1000, 1 × 500

Actual width mm

1000

1200

1400





Levelling plates

To compensate for height. Enable units to be aligned with precision on uneven floors. Specification: PVC. Colour: grey.

Levelling plates

Thickness 1 mm	73.005.000
Thickness 2 mm	73.006.000
Thickness 4 mm	73.007.000
Dimensions (W x D mm)	100 x 200



! Floor anchoring

Heavy-duty pull-out shelving units must always be anchored.

Floor anchor

M10 x 130, each	112.991.000
-----------------	-------------



Column guard PC6

Safety feature to protect exposed side frames. With 4 holes for floor anchoring. Including 4 segment anchors M12 x 140 mm (drill hole depth 140 mm). Specification: sheet steel, St 37-2. Colour: yellow/black.

Column guard PC6

W 166 x D 166 x H 322	43.537.000
-----------------------	------------

! In order to comply with regulations, and for safety reasons, heavy-duty pull-out units must consist of at least these elements



Shelving systems | Heavy-duty pull-out shelving systems fixed and pull-out frames



! Fixed frame

Instead of the top shelves, fixed frames can also be used. The fixed frames are screwed to the side frames. Including screw fasteners. Specification: Pressed profile, welded. Colour: as per colour chart.



Metal sheet covers for fixed frames

Placed on loosely. Locked in place with a bent section at the front and rear and a stop bracket welded on at the rear. Specification: steel sheet, 2 mm thick. Colour: as per colour chart.



Chipboard inserts for fixed frames

2-piece, to be inserted into the fixed frames. Specification: chipboard, 40 mm thick.

or...



Pull-out frames for part extension

Part extension (PE), 65% extension. The pull-out stop secures the pull-out frame in both closed and open positions. The runners are screwed to the side frames. Including screw fasteners. Specification: Pressed profile, welded. Colour: as per colour chart.



Metal sheet covers for pull-out frames (part extension)

With raised edge on 3 sides, 30 mm high, placed on loosely. Locked in place with a bent section at the front and a stop bracket welded on at the rear. Specification: steel sheet, 2 mm thick. Colour: as per colour chart.



Chipboard inserts for pull-out frames (part extension)

2-piece, to be inserted into the pull-out frames for part extension. Specification: chipboard, 40 mm thick.

Installed dimensions mm	D	860	1060	1260
Usable depth mm		840	1040	1240
Fixed frame				
W	Usable width mm	Art. no.	Art. no.	Art. no.
890	860	73.030.XXX	73.031.XXX	73.032.XXX
1090	1060	73.040.XXX	73.041.XXX	73.042.XXX
1290	1260	73.050.XXX	73.051.XXX	73.052.XXX
Load capacity (kg)		1000	900	800

Metal sheet covers for fixed frames

W	Usable width mm	Art. no.	Art. no.	Art. no.
890	860	73.130.XXX	73.131.XXX	73.132.XXX
1090	1060	73.140.XXX	73.141.XXX	73.142.XXX
1290	1260	73.150.XXX	73.151.XXX	73.152.XXX

Chipboard inserts for fixed frames

W	Usable/actual width mm	Art. no.	Art. no.	Art. no.
890	860 / 869	73.430.000	73.431.000	73.432.000
1090	1060 / 1069	73.440.000	73.441.000	73.442.000
1290	1260 / 1269	73.450.000	73.451.000	73.452.000
Actual depth mm (2-part)		345	445	545

Installed dimensions mm	D	860	1060	1260
Usable depth mm		810	1010	1210
Pull-out frames for part extension				
W	Usable width mm	Art. no.	Art. no.	Art. no.
890	800	73.070.XXX	73.071.XXX	73.072.XXX
1090	1000	73.080.XXX	73.081.XXX	73.082.XXX
1290	1200	73.090.XXX	73.091.XXX	73.092.XXX
Load capacity (kg)		1000	900	800

Metal sheet covers for pull-out frames (part extension)

W	Usable width mm	Art. no.	Art. no.	Art. no.
890	800	73.270.XXX	73.271.XXX	73.272.XXX
1090	1000	73.280.XXX	73.281.XXX	73.282.XXX
1290	1200	73.290.XXX	73.291.XXX	73.292.XXX

Chipboard inserts for pull-out frames (part extension)

W	Usable/actual width mm	Art. no.	Art. no.	Art. no.
890	800 / 772	73.470.000	73.471.000	73.472.000
1090	1000 / 972	73.480.000	73.481.000	73.482.000
1290	1200 / 1172	73.490.000	73.491.000	73.492.000
Actual depth mm (2-part)		330	430	530

! In order to comply with regulations, and for safety reasons, heavy-duty pull-out shelving systems must consist of at least these elements.

or...



Pull-out frames for full extension

Full extension (FE), 100% extension. The pull-out stop secures the pull-out frame in both closed and open positions. The runners are screwed to the side frames. Including screw fasteners. Specification: Pressed profile, welded. Colour: as per colour chart.



Metal sheet covers for pull-out frames (full extension)

With raised edge on 3 sides, 30 mm high, placed on loosely. Locked in place with a bent section at the front and a stop bracket welded on at the rear. Specification: steel sheet, 2 mm thick. Colour: as per colour chart.



Chipboard inserts for pull-out frames (full extension)

2-piece, to be inserted into the pull-out frames for full extension. Specification: chipboard, 40 mm thick.



Top Shelves

Cover the top of the side frames and provide protection from dust. Fitting material included. Specification: sheet steel. Colour: according to colour chart.

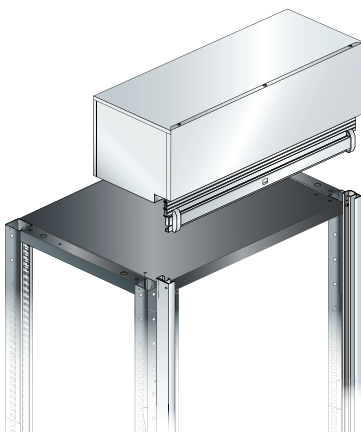

Roller shutter including top shelf

Pre-assembled roller shutter housing. Roller shutter guided in vertical profiles on side frame. With recess for lever tumbler lock. For initial assembly, including top shelf, pre-drilled, for attaching the roller shutter housing. Description: roller shutter housing and guide profiles made of sheet steel. Colours: according to colour chart. Roller shutter with plastic slats. Colour: pale grey, RAL 7035. Note: the height of the shelving is increased by 323 mm due to the design.

Installed dimensions mm		860	1060	1260
Usable depth mm		810	1010	1210

Pull-out frames for full extension

	Usable width mm	Art. no.	Art. no.	Art. no.
890	800	73.210.XXX	73.211.XXX	45.008.XXX
1090	1000	73.212.XXX	73.213.XXX	73.214.XXX
1290	1200	45.009.XXX	73.215.XXX	73.216.XXX
Load capacity (kg)		1000	900	800

Metal sheet covers for pull-out frames (full extension)

	Usable width mm	Art. no.	Art. no.	Art. no.
890	800	73.217.XXX	73.218.XXX	45.250.XXX
1090	1000	73.219.XXX	73.220.XXX	73.221.XXX
1290	1200	45.251.XXX	73.222.XXX	73.223.XXX

Chipboard inserts for pull-out frames (full extension)

	Usable/actual width mm	Art. no.	Art. no.	Art. no.
890	800 / 680	73.224.000	73.225.000	45.252.000
1090	1000 / 880	73.226.000	73.227.000	73.228.000
1290	1200 / 1080	45.253.000	73.229.000	73.230.000
Actual depth mm (2-part)		330	430	530

Installed dimensions mm		860	1060	1260
Usable depth mm		840	1040	1240

Top Shelves

	Usable width mm	Art. no.	Art. no.	Art. no.
890	890	73.650.XXX	73.651.XXX	73.652.XXX
1090	1090	73.660.XXX	73.661.XXX	73.662.XXX
1290	1290	73.670.XXX	73.671.XXX	73.672.XXX
Load capacity (kg)		200	150	100

Installed dimensions mm		860	1060	1260
-------------------------	--	-----	------	------

Roller shutter including top shelf

		Art. no.	Art. no.	Art. no.
2000	890	73.231.XXX	73.232.XXX	73.233.XXX
	1090	73.240.XXX	73.241.XXX	73.242.XXX
	1290	73.249.XXX	73.250.XXX	73.251.XXX
2200	890	73.234.XXX	73.235.XXX	73.236.XXX
	1090	73.243.XXX	73.244.XXX	73.245.XXX
	1290	73.252.XXX	73.253.XXX	73.254.XXX
2500	890	73.237.XXX	73.238.XXX	73.239.XXX
	1090	73.246.XXX	73.247.XXX	73.248.XXX
	1290	73.255.XXX	73.256.XXX	73.257.XXX

+ lever tumbler lock

KEY Lock, Separately lockable	49.090.000
-------------------------------	------------



Shelving systems | Mobile shelf units

A LISTA mobile shelving system is the perfect way to create plenty of storage space in confined areas. When more space is needed in existing premises, LISTA has the perfect solution: create more space without extending. Fixed shelf units are needed only if simultaneous access to all stored items is necessary; otherwise, aisles between shelf units are simply uneconomical. Instead of many space-consuming service aisles between the fixed shelf units, only one single aisle is needed to provide access to all shelving.



A wide variety of equipment options

with different drives and rail systems



Protects against dirt

through horizontal and vertical dust seals



Secure locking option

central locking system and linking hook provide protection against unauthorised access



Outstanding safety features

aisle can be locked during service times; movement of the system is not possible

+ Benefits of LISTA mobile shelf units

Conventional storage

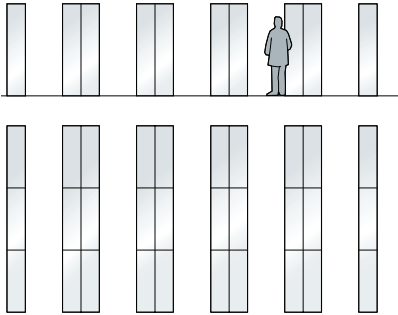

30 shelving units each providing 6 shelf metres = **180 shelf metres.**

Storage with mobile shelf units

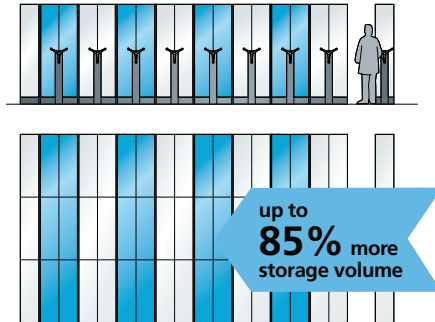

54 shelving units each providing 6 shelf metres = **324 shelf metres.**

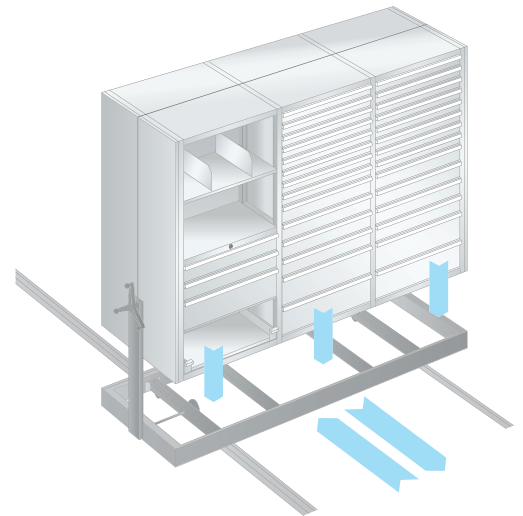

+ Flexible range of applications

LISTA offers suitable storage solutions for all types of stored goods. Universal and drawer storage walls are perfectly suited for use with mobile substructures. LISTA planning specialists utilise the many options offered by the mobile shelf unit system. Every organisation detail is managed according to your requirements – from the design to the turnkey installation of your system.



Universal shelving L1006 R Design "Solid sheet side panel"

Diagonal braces or rear panels ensure stability. Depending on the dimensions and specification, shelves have a load capacity between 80 and 280 kg. The maximum load-bearing capacity of a shelving unit is about 500 kg.

For more information on universal shelving systems see page 220.



Universal shelving L1006 Design "shelf supports"

Suitable for bulky or heavy stored goods. They provide optimum air circulation thanks to their open design. Stability is ensured by diagonal braces or rear panels. Depending on their dimensions, the shelves have a load capacity between 80 and 280 kg. Maximum load capacity per shelving unit up to 1000 kg.

For more information on universal shelving systems see page 220.



Drawer storage walls

The drawer options for small parts or tools are virtually unlimited. The many drawer sizes together with the large range of partition components provide a flexible and adaptable basis for optimum and material-friendly storage.

For more information on drawer storage walls, see page 84.

Vi kan skreddersy innredningen til ditt behov.

Vi står disponible til å bistå i deres prosjekter.

*3D tegninger.

*Oppmålinger.

*Kartlegging av behov.

*Montasje.

Ta gjerne kontakt med oss om du har et behov som ikke finnes i katalogen.



Lista ble grunnlagt i 1945

Hovedkontoret ligger i Sveits.



Produksjonen foregår i Sveits og Tyskland.



Kontaktinfo:

Ing Yngve Ege AS

Postadresse:
Postboks 1 Sentrum
0101 Oslo

Besøksadresse:
Ryenstubben 5
0679 Oslo

Tel: 23 24 10 00
Fax: 23 24 10 01

ege@ege.no

Produktansvarlig.

Navn:

Telefon:

Epost: