

DRILL CHUCKS

EDITION 8.1

RÖHM
driven by technology



Table of contents



DRILL CHUCKS

Quick-action drill chucks industry

SPIRO-I	1006
SPIRO-SK	1007
SUPRA-I	1008
SUPRA-S	1009
SUPRA-SK	1010
SUPRA-SK E	1011

Quick-action drill chucks

EXTRA50-RV	1014
EXTRA80-RV	1016

Key-type drill chucks

PRIMA-I / -M / -S / -L	1020
Drill chuck keys BFS	1023

Two-jaw tapping chucks

Tapping chucks GSF	1024
--------------------	------

Accessories

Taper shank arbors KD	1025
Reducing sleeves RH	1026
Extensions sleeves VLH	1027
Drill and reamer extensions BV	1028

Operation guide



TYPE	SPIRO-I	SPIRO-SK	SUPRA-I	SUPRA-S	SUPRA-SK	SUPRA-SK E
Features	Self-tightening, flat jaws					
Clamping capacity	0 - 16 mm	0 - 13 mm	0 - 16 mm	0,5 - 16 mm	0,5 - 13 mm	1,5 - 13 mm
Mount	B 10/12/ 16/18 J 6	B 16	B 10/12/ 16/18 J 0/1/2/6/33 1/2"-20 3/8"-24	B 12/16/18 1/2"-20 3/8"-24 5/8"-16	B 12/16 1/2"-20 3/8"-24	1/2"-20
Application						
Counterclockwise rotation						
For machines without spindle stop	<input checked="" type="checkbox"/>	<input checked="" type="checkbox"/>	<input checked="" type="checkbox"/>	<input checked="" type="checkbox"/>	<input checked="" type="checkbox"/>	<input checked="" type="checkbox"/>
Radial locking		<input checked="" type="checkbox"/>			<input checked="" type="checkbox"/>	<input checked="" type="checkbox"/>
Impact resistant						
Sleeve	M	M	M	M	M	M
Automatic retightening	<input checked="" type="checkbox"/>	<input checked="" type="checkbox"/>	<input checked="" type="checkbox"/>	<input checked="" type="checkbox"/>	<input checked="" type="checkbox"/>	<input checked="" type="checkbox"/>
Page	1006	1008	1008	1009	1010	1011



yes



metal



machining centers



corded drills



optional



plastic



stationary drills



cordless drills

Operation guide



TYPE	EXTRA50-RV	EXTRA80-RV	PRIMA-I	PRIMA-M / -S / -L
Features	Keyless, radial locking		Key-type	
Clamping capacity	1,5 - 13 mm	1 - 13 mm	0,5 - 26 mm	0,5 - 16 mm
Mount	1/2"-20 9/16"-18	1/2"-20 3/8"-24 9/16"-18 SDS plus 1/4" Hex	B 12/16/ 18/22/24 J 1/2/3/6/33 5/8"-16	B 10/12/16/18 1/2"-20 3/8"-24 5/8"-16 SDS plus 1/4" Hex
Application				
Counterclockwise rotation				
For machines without spindle stop				
Radial locking				
Impact resistant				
Sleeve	M	M F	M	M
Automatic retightening				
Page	1014	1016	1020	1020



percussion drilling



1/4" hexagonal mount



clockwise / counter-clockwise rotation



SDS plus mount



SELF-TIGHTENING

The absolute highlight of the SPIRO and SUPRA drill chucks is the automatic retightening. This function increases the clamping force proportional to the cutting force of the tool during drilling operation. This prevents the drill bit from slipping, even at extreme loads.



Video drill chuck

QUICK-ACTION DRILL CHUCKS INDUSTRY

The high concentricity and the automatic retightening in clockwise rotation are the decisive factors for these drill chucks. Due to the high precision of all individual parts a run-out accuracy of up to 0.05 mm is guaranteed depending on the design.

ADVANTAGES AT A GLANCE

- ⊕ Increase in the clamping force proportional to the cutting force by the automatic retightening function
- ⊕ Precise concentricity of up to 0.05 mm
- ⊕ Long lifetime due to hardened functional parts

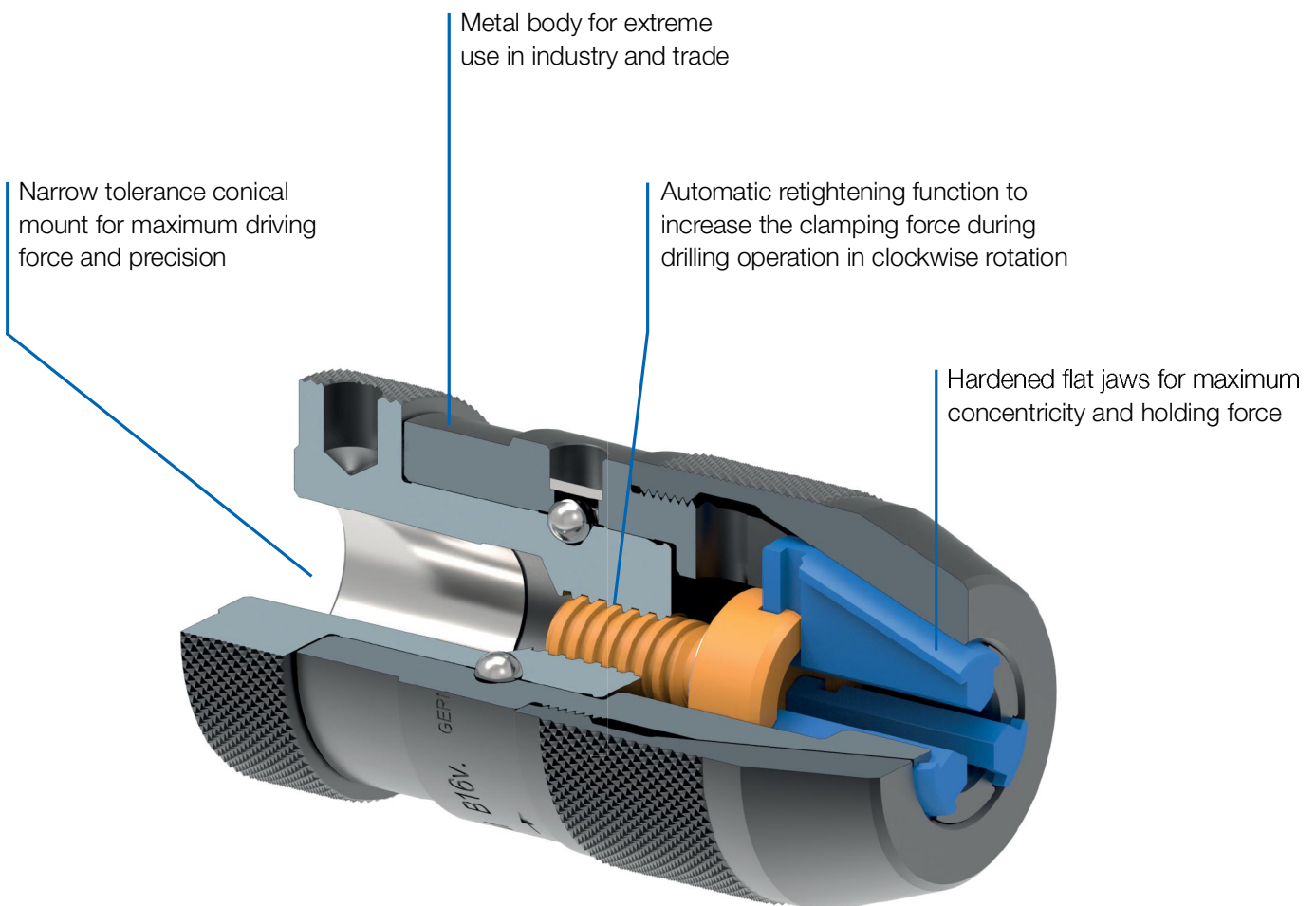

SPIRO-I



APPLICATION

Especially suitable on machining centers, stationary drills and drilling machines with high precision requirements.

TYPE

Self-tightening flat jaw drill chuck.
Industrial design with maximum precision.

CUSTOMER BENEFITS

- ③ Precise concentricity of up to 0.05 mm
- ③ Increase in the clamping force proportional to the cutting force by the automatic retightening function
- ③ Conical mount for maximum driving force and precision

TECHNICAL FEATURES

- Strong retaining ring
- All components made from steel
- Hardened and ground
- Only suitable for clockwise rotation



A03

SPIRO-I for machining centers, stationary drills and drilling machines

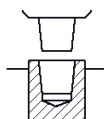

Item no.	Size	Type	Clamping capacity mm	Mount	Concentricity deviation max. mm	External Ø mm	Length opened mm	Length closed mm	Weight g
871003	6	I	0-6,5	B 10	0,05	35	62,5	68,6	315
871004	6	I	0-6,5	B 12	0,05	35	62,5	68,6	310
871008	10	I	0-10	B 12	0,05	43	82,5	90,1	665
871009	10	I	0-10	B 16	0,05	43	82,5	90,1	650
871012	13	I	1-13	B 16	0,05	50	94	102,5	995
871016	16	I	3-16	B 16	0,05	55	96,5	106,8	1260
871017 ¹⁾	16	I	3-16	B 18	0,05	55	96,5	106,8	1250

¹⁾ Shortened: B18 by 7 mm

SPIRO-SK



APPLICATION

Especially suitable on machining centers, stationary drills and drilling machines with high precision requirements.

TYPE

Self-tightening flat jaw drill chuck with metal sleeve and clamping force safety device. Industrial design with maximum precision.

CUSTOMER BENEFITS

- ⊕ Precise concentricity of up to 0.07 mm over the whole clamping range
- ⊕ Increase in the clamping force proportional to the cutting force by automatic retightening function and no releasing in counterclockwise rotation
- ⊕ Conical mount for maximum driving force and precision

TECHNICAL FEATURES

- The locking of the pawl prevents the unintentional release in counterclockwise rotation up to a turning moment of 15 Nm
- All functional parts are hardened and ground



A03
SPIRO-SK for machining centers, stationary drills and drilling machines

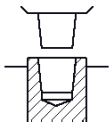

Item no.	Size	Clamping capacity mm	Mount	Concentricity deviation max. mm	External Ø mm	Length opened mm	Length closed mm	Weight g
871070	10	0-10	B 16	0,07	43	81,5	89,1	670
871071 ¹⁾	13	1-13	B 16	0,07	43	85	93,1	1050

¹⁾ Shortened: B16 by 2.5 mm

SUPRA-I



APPLICATION

Especially suitable on stationary drills and hand-operated drills.

TYPE

Self-tightening flat jaw drill chuck.
Industrial design with maximum precision.

CUSTOMER BENEFITS

- ⊕ Precise concentricity of up to 0.12 mm
- ⊕ Increase in the clamping force proportional to the cutting force by the automatic retightening function
- ⊕ Easy and quick clamping of tools for maximum user-friendliness

TECHNICAL FEATURES

- Strong retaining ring
- All components made from steel
- Hardened and superfinished
- Only suitable for clockwise rotation



A02

SUPRA-I heavy industrial design for stationary drills and hand-operated drills

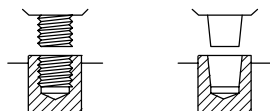

Item no.	Size	Type	Clamping capacity mm	Mount	Concentricity deviation max. mm	External Ø mm	Length opened mm	Length closed mm	Weight g
871020	4	I	0-4	J0	0,12	26	46,5	51,5	130
871019	4	I	0-4	B10	0,12	26	45,5	50,8	137
871025	6	I	0-6,5	3/8"-24	0,2	32	59,5	65,6	301
871024	6	I	0-6,5	J1	0,12	32	59,5	65,6	275
871022	6	I	0-6,5	B10	0,12	32	59,5	65,6	280
871023	6	I	0-6,5	B12	0,12	32	59,5	65,6	250
871032	8	I	0-8	B12	0,12	35,8	67	73,4	345
871040	10	I	0-10	B12	0,12	40,2	79,5	86,1	578
871041	10	I	0-10	B16	0,12	40,2	82,5	89,1	624
871052	13	I	1-13	J2	0,12	46	91	99,5	900
871054	13	I	1-13	J6	0,12	46	94	102,5	870
871051	13	I	1-13	B16	0,12	46	93	101,5	915
871053	13	I	1-13	J33	0,12	46	94	102,5	948
871066	16	I	3-16	J6	0,12	51	96,5	106,8	1120
871064	16	I	3-16	B16	0,12	51	96,5	106,8	1161
871065 ¹⁾	16	I	3-16	B18	0,12	51	96,5	106,8	1115

¹⁾ Shortened: B18 by 7 mm

SUPRA-S



APPLICATION

Suitable for stationary drills and hand-operated drills.

TYPE

Self-tightening flat jaw drill chuck.

CUSTOMER BENEFITS

- ⊕ Concentricity of up to 0.17 mm
- ⊕ Increase in the clamping force proportional to the cutting force by the automatic retightening function
- ⊕ Easy and quick clamping of tools for maximum user-friendliness

TECHNICAL FEATURES

- Strong retaining ring
- All components made from steel
- Hardened and superfinished
- Only suitable for clockwise rotation



A02

SUPRA-S light design mainly for stationary drills and hand-operated drills



Item no.	Size	Type	Clamping capacity mm	Mount	Concentricity deviation max. mm	External Ø mm	Length opened mm	Length closed mm	Weight g
871029	8	S	0-8	3/8"-24	0,25	32	61,5	67,6	285
871038	10	S	0,5-10	3/8"-24	0,25	35,8	66	73,7	370
871039	10	S	0,5-10	1/2"-20	0,25	35,8	66	73,7	377
871049	13	S	1-13	3/8"-24	0,25	40,2	76,3	83,6	610
871050	13	S	1-13	1/2"-20	0,25	40,2	76,3	83,6	548
871046	13	S	1-13	B12	0,17	40,2	78,8	86,1	593
871047 ¹⁾	13	S	1-13	B16	0,17	40,2	82,3	89,6	581
871062	16	S	3-16	1/2"-20	0,25	46	87,5	97,5	880
871063	16	S	3-16	5/8"-16	0,25	46	87,5	97,5	865
871057 ¹⁾	16	S	3-16	B16	0,17	46	88,5	98,5	858
871058 ²⁾	16	S	3-16	B18	0,17	46	92	102	875

¹⁾ Shortened: B16 by 2.5 mm

²⁾ Shortened: B18 by 7 mm

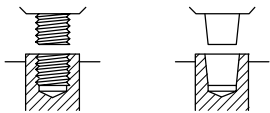

SUPRA-SK



APPLICATION

For extreme use on hand-operated percussion drills and drills up to 1300 watt with mounting thread or conical mount.

TYPE

Impact-resistant and self-tightening flat jaw drill chuck. Also suitable for counterclockwise rotation by radial locking.

CUSTOMER BENEFITS

- ⊕ Concentricity of up to 0.25 mm
- ⊕ Increase in the clamping force proportional to the cutting force by automatic retightening function and no releasing in counterclockwise rotation
- ⊕ Impact-resistant by radial locking for universal use

TECHNICAL FEATURES

- Strong retaining ring
- Hardened and superfinished
- Suitable for counterclockwise rotation up to maximal 15 Nm



A02

SUPRA-SK for hand-operated percussion drills and drills



Item no.	Size	Type	Clamping capacity mm	Mount	Concentricity deviation max. mm	External Ø mm	Length opened mm	Length closed mm	Weight g
249910	10	S	0,5-10	3/8"-24	0,3	40	66	73,7	428
305188	10	S	0,5-10	B 12	0,25	40	68	75,7	416
249804	13	S	1-13	1/2"-20	0,3	42,8	74,2	83,3	537
305221	13	S	1-13	B 12	0,25	42,8	77	86,1	575
305203 ¹⁾	13	S	1-13	B 16	0,25	42,8	80,2	89,3	585

¹⁾ Shortened: B16 by 2.5 mm

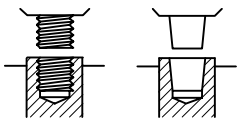

SUPRA-SK E



APPLICATION

Especially suited for hand-operated percussion drills, drills and cordless drills up to 70 Nm of torque.

TYPE

Impact-resistant and self-tightening flat jaw drill chuck. Also suitable for counterclockwise rotation by radial locking.

CUSTOMER BENEFITS

- ⊕ Concentricity of up to 0.35 mm
- ⊕ Increase in the clamping force proportional to the cutting force by automatic retighteningfunction and no releasing in counterclockwise rotation
- ⊕ Impact-resistant by radial locking for universal use

TECHNICAL FEATURES

- Hardened and superfinished
- Suitable for counterclockwise rotation up to maximal 50 Nm



A02

SUPRA-SK E for hand-operated percussion drills and drills up to 1000 watt and cordless drills with up to 70 Nm of torque

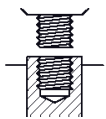

Item no.	Size	Type	Clamping capacity mm	Mount	Retaining ring	Concentricity deviation max. mm	External Ø mm	Length opened mm	Length closed mm	Weight g
1193004	13	E	1,5-13	1/2"-20		0,35	42,9	72,0	79,3	402
1193005	13	E	1,5-13	1/2"-20	•	0,35	42,5	72,0	79,3	390



MAXIMUM USER-FRIENDLINESS

The EXTRA-RV drill chucks impress with their user-friendliness. The drill chuck is tightened and locked with a single manual operation. The radial locking device prevents the unintentional release of the drill bit during clockwise and counterclockwise rotation and makes percussion drilling possible. Thus, these quick-action drill chucks are predestined for use on hand-operated drills.



Video drill chuck

QUICK-ACTION DRILL CHUCKS

Due to the weight-reduced design as well as the easy handling, the RÖHM EXTRA-RV drill chucks are optimally suited for use on hand-operated drills. In addition, the drill chucks are impact-resistant and can therefore be used universally.

ADVANTAGES AT A GLANCE

- ⊕ Easy clamping and locking with one hand operation for maximum user-friendliness
- ⊕ Radial locking device to prevent release of the drill bit during clockwise and counterclockwise rotation
- ⊕ Impact-resistant for universal use

Compact and weight-reduced design for optimal use on hand-operated drills

Radial locking device to prevent unintentional release of the drill bit during clockwise and counterclockwise rotation

Freely rotating protection disc to prevent damage

Minimal wear through clamping jaws with carbide inserts

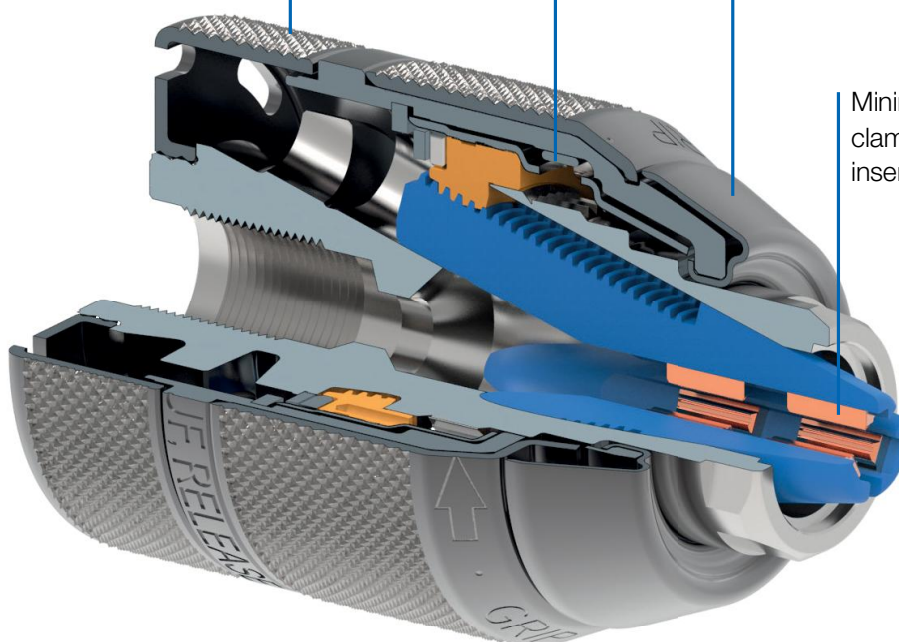

EXTRA50-RV



APPLICATION

Drill chuck specially designed for cordless drills with spindle stop up to a maximum torque of 80 Nm.

TYPE

Impact-resistant quick-action drill chuck with radial locking and metal sleeve. With through-hole for use of a locking screw.

CUSTOMER BENEFITS

- ③ Very compact design reducing the top-heaviness of the entire cordless drill
- ③ Easy clamping and locking with one manual operation offering maximum user-friendliness
- ③ Radial locking device to prevent inadvertent release of the drill bit during clockwise and counterclockwise rotation. Impact resistant.

TECHNICAL FEATURES

- With carbide inserts in the clamping jaws
- Equipped with collision protector by freely rotating protection disc



A01

EXTRA50-RV with radial locking, metal design



Item no.	Size	Clamping capacity mm	Mount	Retaining ring	Design	Concentricity deviation max. mm	External Ø mm	Length opened mm	Length closed mm	Max. torque Nm	Through-hole
1322450	13	1,5-13	9/16-18"		Metal	0,4	42,4	51	60,9	80	•
1322451	13	1,5-13	1/2"-20		Metal	0,4	42,4	51	60,9	80	•

Note: locking screw is not included in scope of delivery



Notes

EXTRA80-RV



APPLICATION

For corded and cordless drills with and without spindle stop up to a maximum torque of 100 Nm and up to 1500 watt.

TYPE

Impact-resistant quick-action drill chuck with radial locking and plastic or metal sleeve.
Optional with retaining ring for machines without spindle stop.
With through-hole for use of a locking screw.

CUSTOMER BENEFITS

- ☑ Easy clamping and locking with one manual operation for maximum user-friendliness
- ☑ Radial locking device to prevent release of the drill bit during clockwise and counterclockwise rotation
- ☑ Impact-resistant for universal use

TECHNICAL FEATURES

- With carbide inserts in the clamping jaws
- Equipped with collision protector by freely rotating protection disc



A01
EXTRA80-RV with radial locking, metal design



Item no.	Size	Clamping capacity mm	Mount	Retaining ring	Design	Concentricity deviation max. mm	External Ø mm	Length opened mm	Length closed mm	Max. mach. capacity watt	Through-hole
1328321	10	1-10	3/8"-24		metal	0,4	42,7	55	60,9	550	•
1328318	10	1-10	1/2"-20		metal	0,4	42,7	55	60,9	550	•
1328317	10	1-10	1/2"-20	•	metal	0,4	42,7	55	60,9	550	•
1328314	13	1,5-13	3/8"-24	•	metal	0,4	42,7	64,5	72,4	1500	•
1328311	13	1,5-13	1/2"-20		metal	0,4	42,7	64,5	72,4	1500	•
1328310	13	1,5-13	1/2"-20	•	metal	0,4	42,7	64,5	72,4	1500	•
1339960	13	1,5-13	9/16"-18		metal	0,4	42,7	64,5	72,4	1500	•

Note: locking screw is not included in scope of delivery

A01
EXTRA80-RV with radial locking, plastic design



Item no.	Size	Clamping capacity mm	Mount	Retaining ring	Design	Concentricity deviation max. mm	External Ø mm	Length opened mm	Length closed mm	Max. mach. capacity watt	Through-hole
1328323	10	1-10	3/8"-24		plastic	0,4	42,7	55	60,9	550	•
1328322	10	1-10	3/8"-24	•	plastic	0,4	42,7	55	60,9	550	•
1328320	10	1-10	1/2"-20		plastic	0,4	42,7	55	60,9	550	•
1328319	10	1-10	1/2"-20	•	plastic	0,4	42,7	55	60,9	550	•
1328316	13	1,5-13	3/8"-24		plastic	0,4	42,7	64,5	72,4	1300	•
1328315	13	1,5-13	3/8"-24	•	plastic	0,4	42,7	64,5	72,4	1300	•
1328313	13	1,5-13	1/2"-20		plastic	0,4	42,7	64,5	72,4	1300	•
1328312	13	1,5-13	1/2"-20	•	plastic	0,4	42,7	64,5	72,4	1300	•

Note: locking screw is not included in scope of delivery

EXTRA80-RV

A01
EXTRA80-RV with SDS plus mounting shank and radial locking, metal design



Item no.	Size	Clamping capacity mm	Mount	Retaining ring	Design	External Ø mm	Length opened without SDS-shank mm	Length closed without SDS-shank mm
1288566	13	1,5-13	1/2"-20 / SDS plus	•	metal	42,7	64,5	72,4

Use only with deactivated percussion function



A01
EXTRA80-RV for impact screwdriver mounting 1/4" Hex, plastic design, specially suited for impact screwdrivers (eccentricity)



Item no.	Size	Clamping capacity mm	Mount	Retaining ring	Design	External Ø mm	Length opened without SDS-shank mm	Length closed without SDS-shank mm
1178269	10	1-10	1/4"-Hex	•	plastic	42,7	55	63,1



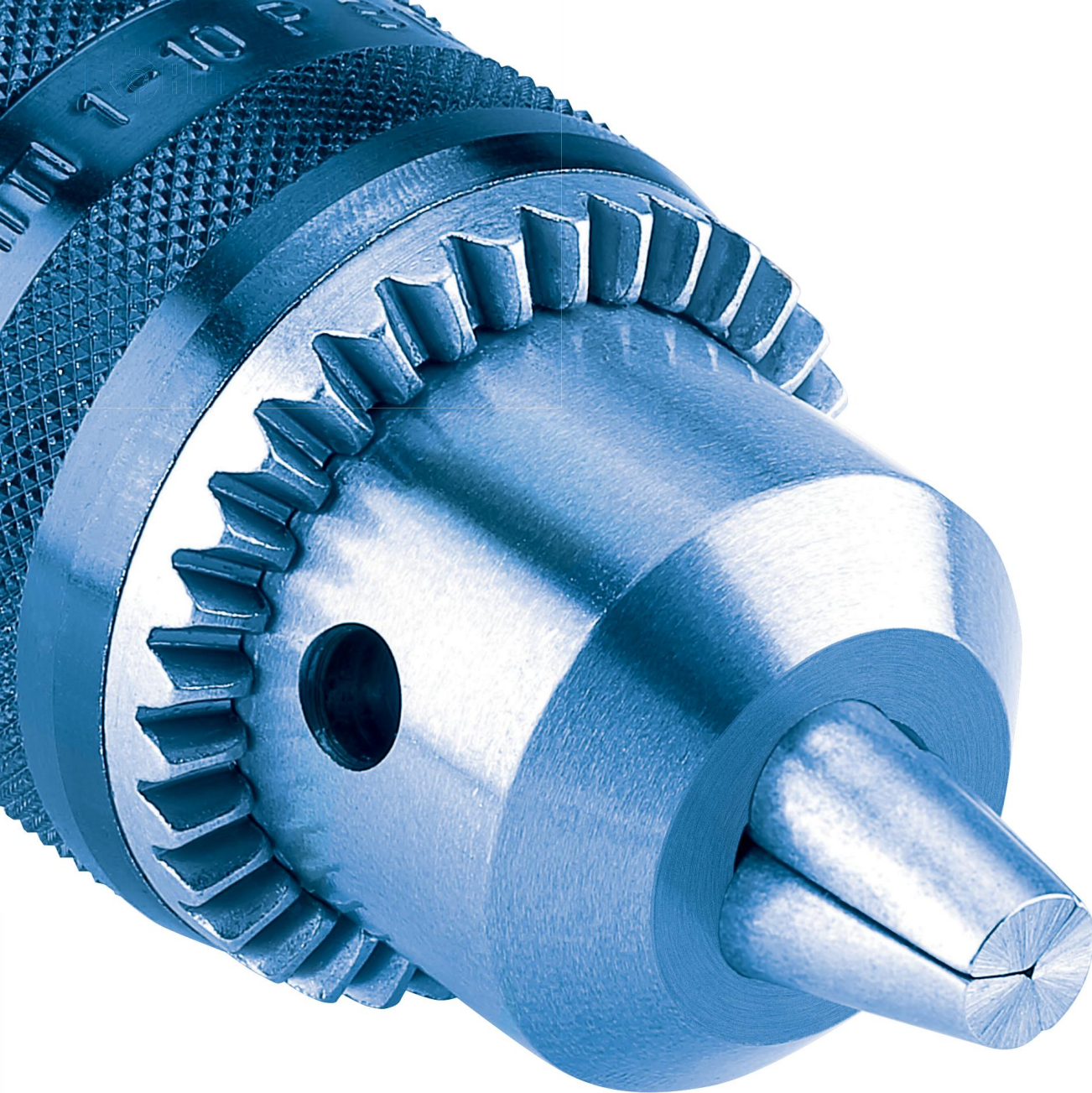

UNIVERSALLY APPLICABLE

Key-type drill chucks are the all-round talents among drill chucks. In stationary drills, hand-operated corded and cordless drills, the drill chucks perform in every way.



Video drill chuck

KEY-TYPE DRILL CHUCKS

Key-type drill chucks from RÖHM convince with their universal applicability. These drill chucks have proven themselves over decades on stationary drills, machine tools, as well as on hand-operated corded and cordless drills. Increased power transmission is achieved due to the solid construction and the use of drill chuck keys.

ADVANTAGES AT A GLANCE

- ⊕ Universally applicable for stationary use and on hand-operated drills
- ⊕ High concentricity of up to 0.15 mm due to solid type of construction
- ⊕ Increased clamping force due to proven transmission principle by means of drill chuck key

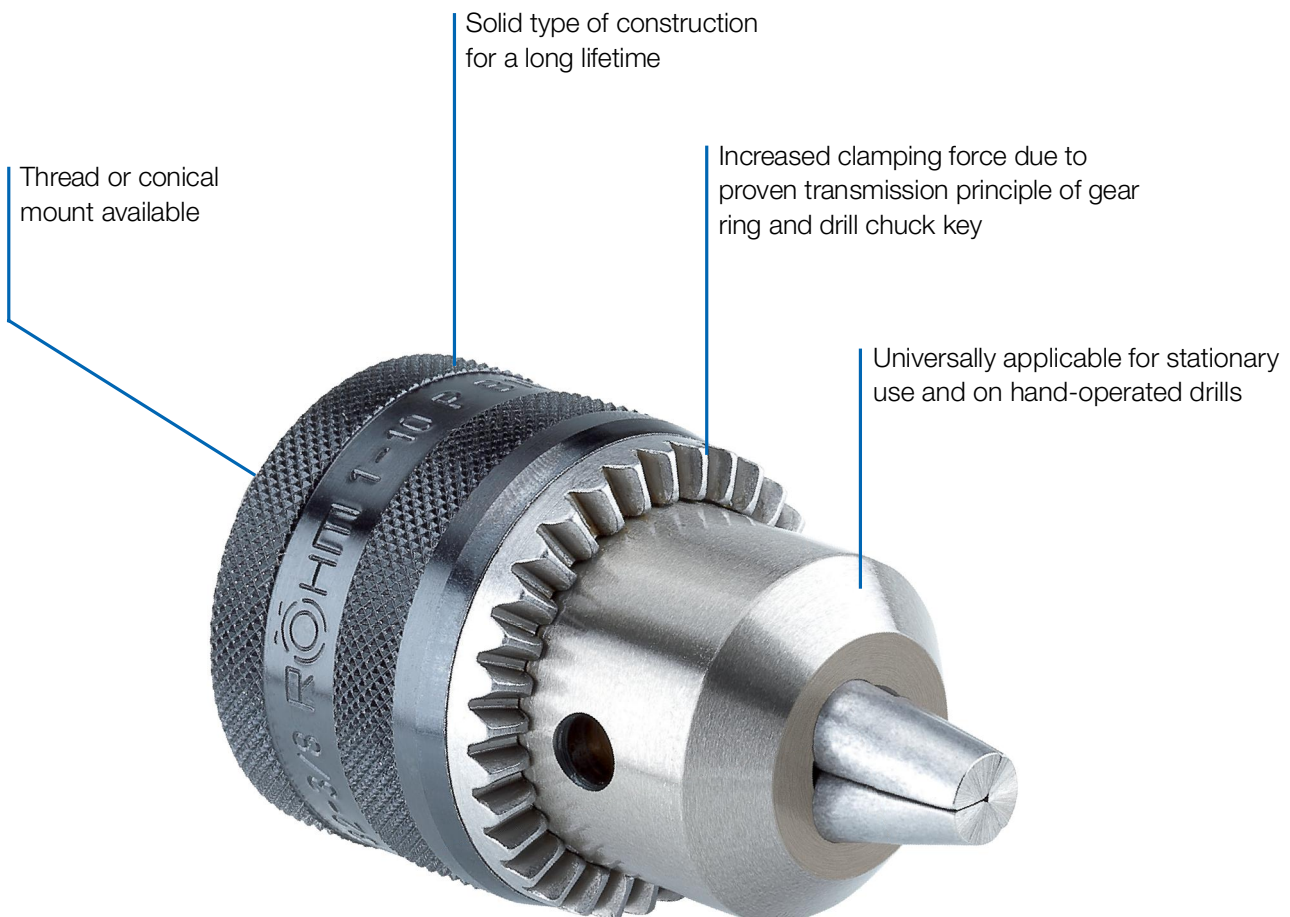



APPLICATION

PRIMA-I: For universal use on stationary drills as well as machine tools.

PRIMA-S / -M: For universal use on stationary drills as well as hand-operated corded and cordless drills.

PRIMA-L: For universal use on do-it-yourself drills.

TYPE

Impact-resistant key-type drill chuck with key. Conical/threaded mount in acc. with DIN ISO 10887 (toothing in acc. with DIN 6349). For clockwise and counterclockwise rotation.

CUSTOMER BENEFITS

- ⊕ High concentricity of up to 0.15 mm
- ⊕ Increased clamping force due to proven transmission principle by means of drill chuck key

TECHNICAL FEATURES

- Hardened keyholes and clamping prism for type -I, -S, -M



A01

PRIMA-I for stationary drills as well as machine tools

PRIMA-S / -M primarily for hand-operated percussion drilling machines

PRIMA-L for universal use on do-it-yourself drills

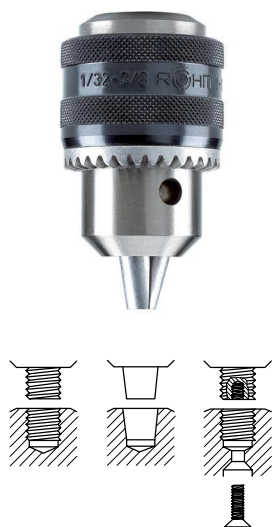

Item no.	Size	Type	Clamping capacity mm	Mount	Concentricity deviation max. mm	External Ø mm	Length opened mm	Length closed mm	Key size	Through-hole
072811	6	M	0,5-6,5	3/8"-24	0,2	29,5	42,5	53	S1	
245586	6	M	0,5-6,5	B10	0,2	29,5	43	53	S1	
072656	8	I	0,5-8	J1	0,15	34,5	48	58,5	S2A	
245550	8	M	0,5-8	B12	0,23	29,5	47,5	57,5	S1	
245552	8	M	0,5-8	3/8"-24	0,28	29,5	42,5	53	S1	
072687	10	I	1-10	B16	0,2	42,8	63	77	S2A	
072693	10	I	1-10	J2	0,2	42,8	61,5	75,5	S2A	
072653	10	S	0,8-10	B12	0,23	34,5	50	60,5	S2A	
317255	10	S	0,8-10	3/8"-24	0,28	34,5	49,5	61	S2A	•
317256	10	S	0,8-10	1/2"-20	0,28	34,5	49,5	61	S2A	•
1322220	10	L	1-10	3/8"-24	0,35	33,35	49,5	61	S2A	•
1322221	10	L	1-10	1/2"-20	0,35	33,35	49,5	61	S2A	•
072818	13	I	1-13	J6	0,2	50	67,5	86	S3	
072819	13	I	1-13	J33	0,2	50	67,5	86	S3	
064527	13	S	1,5-13	3/8"-24	0,28	42,8	59	74	S2A	
317257	13	S	1,5-13	1/2"-20	0,28	42,4	59	74	S2A	•
072800	13	S	1,5-13	B16	0,25	42,8	63	77	S2A	
072897	13	S	1,5-13	B12	0,25	42,8	58	72	S2A	
1322222	13	L	1,5-13	3/8"-24	0,35	42,4	59	74	S2A	•
1322223	13	L	1,5-13	1/2"-20	0,35	42,4	59	74	S2A	•
072825	16	I	1-16	B18	0,2	56,5	79	98	S3	
072827	16	I	1-16	J3	0,2	56,5	79	98	S3	
1322236	16	M	3-16	5/8"-16	0,3	50	68,5	87,5	S3	
072866	16	M	3-16	1/2"-20	0,3	50	68,5	87,5	S3	
227152	16	M	3-16	B16	0,25	50	67,5	86,5	S3	
072831	20	I	5-20	B22	0,25	65	92,5	113,5	S4	
072833	20	I	5-20	J3	0,25	65	82,5	103,5	S4	
072834 ¹⁾	26	I	5-26	B24	0,25	80	120	147	S4	

1) With driver

Note: locking screw is not included in scope of delivery

PRIMA

A01

PRIMA-Mat (LT-MT) key-type drill chuck with excentric clamping force safety device



Item no.	Size	Type	Clamping capacity mm	Mount	External Ø mm	Length opened mm	Length closed mm	Key size	Through-hole
1196033	16	MT	3-16	M18x2,5	50	68,5	87,5	S3T	•
329718	16	LT	3-16	5/8"-16	50	68,5	87,5	S3T	

For percussion drills with a high impact frequency
With through-hole for clockwise and counterclockwise rotating drills and percussion drills with locking screw M5 or M6

A01

PRIMA 6L, hexagon



Item no.	Size	Type	Clamping capacity mm	Mount	External Ø mm	Length opened mm	Length closed mm	Key size
368292	6	L	0,5-6,5	hexagon	29,3	42,5	53	S14

For clockwise and counterclockwise rotation
Use only with switched-off impact function



A01

PRIMA-NIRO, key-type drill chuck made from stainless steel



Item no.	Size	Type	Clamping capacity mm	Mount	Concentricity deviation max. mm	External Ø mm	Length opened mm	Length closed mm	Key size
399782	7	Niro	0,5-7	3/8"-24	0,2	23,7	34	42,5	S1

Special type for medical-, laboratory- and food-technology

PRIMA

A01

PRIMA with SDS plus mounting shank



Item no.	Clamping capacity mm	Mount	External Ø mm	Length opened without SDS-shank mm	Length closed without SDS-shank mm	Key size
1288568	1,5-13	1/2"-20 / SDS plus	42,9	59	74	S2A

Use only with deactivated hammer function



A01

HBF hammer drill chuck with SDS plus adapter



Item no.	Size	Type	Clamping capacity mm	Mount	External Ø m	Length opened without SDS-shank mm	Length closed without SDS-shank mm	Key size
600581	13	HBF	2,5-13	SDS plus	42,9	68	81,5	S2A

With carbide inserts in the clamping jaws

Axial play for transmitting the entire impact onto the drill with switched-on percussion function

For clockwise and counterclockwise rotation



Drill chuck keys BFS

A01

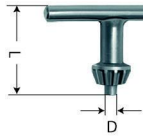
 Keys with **DIN tooting 6349** for key-type drill chucks

Item no.	Size	D mm	L mm	Weight approx. g
026411	S1	4	30	25
205989	S2A	6	41	50
025835	S3	8	50	100
025839	S4	9	55	115

A01

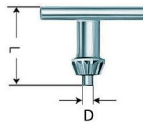
 Keys with **DIN tooting 6349** for key-type drill chucks

Item no.	Size	D mm	L mm	Weight approx. g
309380	S2A T	6	42	50
309382	S3 T	8	51	90

A01

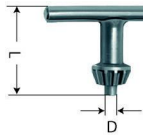
 Key with **Jacobs-tooting** for key-type drill chucks

Item no.	Size	D mm	L mm	Weight approx. g
307319	S14	6,1	30	50

Accessories

A01

SDS plus adapter for drill chucks with 1/2"-20 mount

Item no.	Size	Mount	L mm	Weight approx. g
1322404	1/2"-20	SDS plus	62	50

The adapter serves as a connection to use a conventional drill chuck on hammers with SDS plus mounting. With deactivated hammer function the usage of cylindrical drill bits is now possible. The scope of delivery includes a safety screw with left-hand thread M6x23.

Assembly instruction:

Assemble the SDS adapter to the chuck with 50 Nm.
Fix the safety-screw with approx. 3-5 Nm.

Tapping chucks GSF



APPLICATION

Tapping chucks for handheld and stationary machines.

TECHNICAL FEATURES

- With conical mount for clockwise and counterclockwise rotation
- All around 15° deflection of the tap tool possible
- Simple handling
- Heavy-duty construction, all components made from steel
- All wear parts are hardened and ground

A03

GSF without locking pin



Item no.	Size	Mount	Square clamping width mm	For taps	External Ø mm	Length mm	Key	Set of jaws
319605	9	B10	3-9	M 3,5-14	28	73	026416	309341
303081	9	B12	3-9	M 3,5-14	28	73	026416	309341

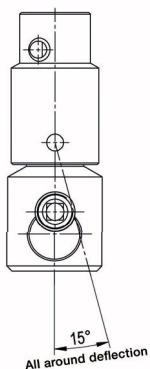

A03

GSF with locking pin for an additional lock of the cone



Item no.	Size	Mount	Square clamping width mm	For taps	External Ø mm	Length mm	Key	Set of jaws
307158	9	B12	3-9	M 3,5-14	28	73	026416	309341

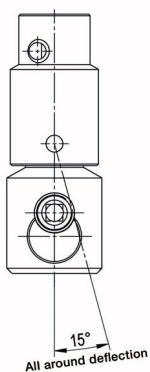

Taper shank arbors KD

A04

Taper shank arbors with drill chuck taper DIN 238 completely hardened and ground



Item no.	Morse taper DIN 228 B	Drill chuck taper	L mm	A mm	C mm	E mm	G mm	H mm	Weight approx. g
014897	1	B10	86	62	12,065	14,5	10,095	9,4	55
014898	1	B12	89	62	12,065	18,5	12,065	11,1	65
014899	1	B16	97	62	12,065	24	15,733	14,5	90
014900	1	B18	106	62	12,065	32	17,78	16,2	110
018755 ¹⁾	1	B18	97	62	12,065	25	17,431	16,2	95
014904	2	B10	103,5	75	17,78	14,5	10,095	9,4	130
014905	2	B12	106,5	75	17,78	18,5	12,065	11,1	135
014906	2	B16	110,5	75	17,78	24	15,733	14,5	160
014907	2	B18	117,5	75	17,78	32	17,78	16,2	180
018756 ¹⁾	2	B18	108,5	75	17,78	25	17,431	16,2	165
014908	2	B22	128,5	75	17,78	40,5	21,793	19,8	245
014911	3	B12	125	94	23,825	18,5	12,065	11,1	280
014912	3	B16	134	94	23,825	24	15,733	14,5	310
014913	3	B18	141	94	23,825	32	17,78	16,2	320
018757 ¹⁾	3	B18	132	94	23,825	25	17,431	16,2	320
014914	3	B22	147	94	23,825	40,5	21,793	19,8	390
014915	3	B24	158	94	23,825	50,5	23,825	21,3	440
014916	4	B16	159	117,5	31,267	24	15,733	14,5	625
014917	4	B18	168	117,5	31,267	32	17,78	16,2	660
018758 ¹⁾	4	B18	159	117,5	31,267	25	17,431	16,2	640
014918	4	B22	176	117,5	31,267	40,5	21,793	19,8	715
014919	4	B24	185	117,5	31,267	50,5	23,825	21,3	770
014920	5	B16	196	149,5	44,399	24	15,733	14,5	1600
014921	5	B18	204,5	149,5	44,399	32	17,78	16,2	1600
018759 ¹⁾	5	B18	195,5	149,5	44,399	25	17,431	16,2	1560
014922	5	B22	213,5	149,5	44,399	40,5	21,793	19,8	1650
014923	5	B24	224,5	149,5	44,399	50,5	23,825	21,3	1700

¹⁾ For SUPRA and SPIRO with shortened mounting taper
Taper shank arbors with tapped shank (type 238) or cylindrical shank type (type 237) on request

A04

Taper shank arbors with Jacobs drill chuck taper completely hardened and ground



Item no.	Morse taper DIN 228 B	Drill chuck taper	L mm	A mm	C mm	E mm	G mm	H mm	Weight approx. g
014970	1	J1	86,5	62	12,065	16,7	9,754	8,5	50
014971	1	J2	92	62	12,065	22,2	14,199	12,4	70
014972	1	J3	101	62	12,065	31	20,599	19	50
014974	1	J6	95	62	12,065	25,4	17,17	15,9	50
014976	2	J1	101	75	17,78	16,7	9,754	8,5	130
014977	2	J2	106,5	75	17,78	22,2	14,199	12,4	160
014978	2	J3	115,5	75	17,78	31	20,599	19	200
014980	2	J33	109,5	75	17,78	25,4	15,85	14,2	160
014981	2	J6	109,5	75	17,78	25,4	17,17	15,9	165
014983	3	J2	126	94	23,825	22,2	14,199	12,4	310
014984	3	J3	135	94	23,825	31	20,599	19	350
014987	3	J33	129	94	23,825	25,4	15,85	14,2	310
014988	3	J6	129	94	23,825	25,4	17,17	15,9	310
014991	4	J3	161	117,5	31,267	31	20,599	19	475
014995	4	J6	155	117,5	31,267	25,4	17,17	15,9	620

Reducing sleeves RH

A05

Precision design DIN 2185 completely hardened, ground internal and external



Item no.	External taper MT	Internal taper MT	L mm	Weight approx. g
017017	1	0	80	30
017018	2	1	92	95
017019	3	1	99	250
017020	3	2	112	190
017021	4	1	124	550
017022	4	2	124	480
017023	4	3	140	360
017024	5	1	156	1700
017025	5	2	156	1520
017026	5	3	156	1360
017027	5	4	171	950
017028	6	2	218	4300
017029	6	3	218	4100
017030	6	4	218	3600
017031	6	5	218	2550

A05

Taper drift



Item no.	for MT	Length mm	Weight g
017075	0	90	14
017076	1+2	140	70
017077	3	190	150
017078	4	225	310
017079	5+6	265	650

A05

Taper drift for one-hand-operation



Item no.	for MT	Length mm	Weight g
317236	1-3	320	320
317258	4-6	380	520

Extensions sleeves VLH

A05

Precision design DIN 2187 completely hardened, ground internal and external



Item no.	External taper MT	Internal taper MT	D mm	L1 mm	L2 mm	Weight approx. g
029122	1	1	20	145	83	190
029123	1	2	30	160	98	340
029124	2	1	20	160	85	250
029125	2	2	30	175	100	400
029126	2	3	36	196	121	840
029127	3	1	20	175	81	400
029128	3	2	30	194	100	550
029129	3	3	36	215	121	1000
029130	3	4	48	240	146	1500
029131	4	1	20	200	82,5	800
029132	4	2	30	215	97,5	850
029133	4	3	36	240	122,5	1300
029134	4	4	48	265	147,5	1900
029135	4	5	63	300	182,5	3310
029136	5	1	20	232	82,5	1800
029137	5	2	30	247	97,5	1900
029138	5	3	36	268	118,5	2150
029139	5	4	48	300	150,5	2750
029140	5	5	63	335	185,5	4200
029141	6	4	48	355	145	5420
029142	6	5	63	390	180	6750

Drill and reamer extensions BV

A05

Precision design completely hardened, ground internal and external



Item no.	External taper MT	Internal taper MT	D mm	L1 mm	L2 mm	Weight approx. g
029143	1	1	20	200	138	250
029144	1	1	20	250	188	375
029145	1	1	20	300	238	500
029146	1	1	20	350	288	625
029147	1	1	20	400	338	750
029148	1	1	20	450	388	875
029149	1	1	20	500	438	1000
029150	2	2	25	200	125	430
029151	2	2	25	250	175	625
029152	2	2	25	300	225	820
029153	2	2	25	350	275	1015
029154	2	2	25	400	325	1200
029155	2	2	25	450	375	1400
029156	2	2	25	500	425	1600
029157	2	2	25	600	525	1800
029158	3	3	32	250	156	1000
029159	3	3	32	300	206	1300
029160	3	3	32	350	256	1550
029161	3	3	32	400	306	1850
029162	3	3	32	450	356	2100
029163	3	3	32	500	406	2400
029164	3	3	32	600	506	2700
029165	4	4	40	300	182,5	1650
029166	4	4	40	350	232,5	2150
029167	4	4	40	400	282,5	2650
029168	4	4	40	450	332,5	3100
029169	4	4	40	500	382,5	3600
029170	4	4	40	600	482,5	4200



Notes



The headquarters: our main plant in Sontheim/Brenz

The RÖHM main plant is located in Sontheim/Brenz. In this ultra-modern production facility comprising 41,000 m² optimum conditions have been achieved in order to solve the extensive range of discerning construction and production tasks making the company even better, faster and more efficient in the future.



Sontheim/Brenz

Sontheim | All national and international activities are planned and coordinated at the administrative headquarters in Sontheim. Thanks to the excellent infrastructure and transport routes, this location is ideal for a company relying on perfect product quality as well as maximum flexibility. Furthermore, the region around Sontheim offers another key basis for the success of our company: it is rich in quality awareness and motivated employees with the result that we are ideally prepared for the challenges of the future. The main plant uniquely unites mass production, serial production and customised individual production under a single roof.

Key locations for the company: Dillingen and St. Georgen

Such strong growth on the part of the RÖHM Group is also obviously associated with higher requirements on development and production capacities. The demands of today and tomorrow can be complied with the two facilities in Dillingen and St. Georgen.



Dillingen/Danube



St. Georgen

Plant Dillingen/Danube | This branch plant in Dillingen was put into operation by the RÖHM Group as early as 1953. Thanks to extremely positive development, the plant is subject to constant expansion and modernisation. For this reason, new modern production facilities were built in 1982 and 1991. In 2007 RÖHM built a new production hall for two portal turning and milling machines. This enables machining of workpieces up to 4 metres in length which will secure a leading market position for RÖHM in the future. More than 300 employees are primarily involved in engineering and manufacturing lathechucks, machine vices and special clamping equipment for turning and milling machinery as well as for machining centres.

Engineering and sales department St. Georgen | Apart from standard mandrels, tailor-made solutions for a wide variety of requirements are also manufactured here in this small but accomplished high-tech forge. RÖHM retains mechanical or power-operated mandrels, sliding jaw mandrels and hydraulic mandrels for its customers for tensioning workpieces in drill holes or interior contours.

Always close to our customers. With locations all around the world.



Customer orientation at RÖHM has less to do with marketing than with attitude. We consider customer proximity as an intensive dialogue with our partners as well as direct presence on key international markets.



Your contacts at RÖHM

Manufacturing and distribution bases

Germany:

RÖHM GmbH
Heinrich-Röhm-Straße 50
89567 Sontheim/Brenz
Tel 0049 73 25 – 16 0
Fax 0049 73 25 – 16 510
info@roehm.biz
www.roehm.biz

RÖHM GmbH

Röhmstraße 6
89407 Dillingen
Tel 0049 90 71 – 5 08-0
Fax 0049 90 71 – 5 08-174
infodlg@roehm.biz

RÖHM GmbH

Feldbergstr. 5
78112 St. Georgen
Tel 0049 – 77 24 – 94 68 12
Fax 0049 – 77 24 – 51 89
Mobil 0152 – 22 88 70 50
stg.info@roehm.biz

Brazil:

RÖHM IND. E COM. DE
FERRAMENTAS DE FIXAÇÃO LTDA.
Rod. Raposo Tavares, Km 14 - Bloco A
2º andar - sala 2 - CEP 05576-100
São Paulo
Tel 0055 – 11 – 37 32 22 22
Fax 0055 – 11 – 37 35 30 97
vendas@roh.com.br
www.br.roehm.biz

China:

ROEHM China Co., Ltd.
Room 702, Building 24,
No. 518 Xinzhuan Road,
Songjiang District,
201612 Shanghai
Tel 0086 – 21 – 37 70 53 95
Fax 0086 – 21 – 37 70 53 76
roehmcn@roehm.biz

Czech Republic:

RÖHM SLOVAKIA S.R.O.
Partizanska 73
95701 Banovce nad Bebravou
Slovakia
Tel 00421 – 3 87 60 02 22
Fax 00421 – 3 87 60 02 24
Mobil 00421 – 902 556 777
info@roehm.sk

France:

RÖHM S.A. R. L.
325 rue Paul Langevin
BP 90204
F-60744 Saint Maximin cedex
Tel 0033 – 344 64 10 00
Fax 0033 – 344 64 00 68
fr.roehm@roehm.biz
www.rohm.fr

Great Britain:

ROHM (Great Britain) LTD.
Unit 12 the ashway centre
Elm crescent Kingston-upon-Thames
Surrey KT 2 6 HH
Tel 0044 – 20 85 49 66 47
Fax 0044 – 20 85 41 17 83
rohmgbr@roehm.biz
www.uk.roehm.biz

Italy:

RÖHM Italia S.R.L.
Via Reiss Romoli 17-19
20019 Settimo Milanese (MI)
Palazzo Rothenberger
Tel 0039 – 02 – 92 10 35 31
Fax 0039 – 02 – 92 10 17 53
rohmitalia@roehm.biz
www.roehm-italia.it

Mexico:

RÖHM Products México S. de R.L.
Emilio Garza Meléndez #6606
Col. Campestre Mederos
Monterrey, N.L., México, C.P. 64970
Tel 0052 81 – 9627 – 0686
info@roh-products.com

Switzerland:

RÖHM Spanntechnik AG
Feldstraße 39, 3360 Herzogenbuchsee
Tel 0041 – 629 56 30 20
Fax 0041 – 629 56 30 29
roehmch@roehm-spanntechnik.ch
www.ch.roehm.biz

Singapore:

RÖHM Asia Pacific Pte. Ltd.
8 Ubi Road 2
#07-10 Zervex
Singapore 408538
Tel 0065 – 64 43 77 48
Mobil 0065 – 83 28 89 80
info@sg.roehm.biz
www.sg.roehm.biz

Slovakia:

RÖHM SLOVAKIA S.R.O.
Partizanska 73
95701 Banovce nad Bebravou
Slovakia
Tel 00421 – 3 87 60 02 22
Fax 00421 – 3 87 60 02 24
Mobil 00421 – 9 14 12 29 32
info@roehm.sk

Spain:

RÖHM Iberica S.A.
C/Rejas, No. 9 Nave 11 D
28022 Madrid
Tel 0034 – 91 – 3 13 57 90
Fax 0034 – 91 – 3 13 57 93
rohmiiberica@roehm.biz
www.roehm-iberica.es

USA:

ROHM Products of America
2500 Northlake Drive
30024 Suwanee, GA
Tel 001 – 770 – 963 – 8440
Fax 001 – 770 – 963 – 8407
rohmosa@roehm.biz
www.us.roehm.biz

Poland:

RÖHM Polska Sp. z o.o.
Aleje Jerozolimskie 424A
05-800 Pruszków
Tel 0048 – 22 – 759 – 59 90
Fax 0048 – 22 – 759 – 59 99
roehmpolska@roehm.biz

Portugal:

RÖHM Iberica S.A.
C/Rejas, No. 9 Nave 11 D
28022 Madrid
Tel 0035 1926 85 38 81
es.pjfernandes@roehm.com
www.roehm-iberica.es

Hungary:

RÖHM Hungaria Kft.
Gyár u. 2. (BITEP Ipari Park)
H-2040 Budaörs
Tel 0036 – 209 – 324 597
jozsef.alker@roehm.biz

Presence on all continents from A for Australia to V for Vietnam. You can receive the contact information of our worldwide representations easily through www.roehm.biz.



Sales Agents in Germany

Baden-Wuerttemberg:

Thomas Haas
Tel 0 77 25 / 91 48 95
Mobile 0152 / 22 88 71 20
thomas.haas@roehm.biz

Dominik Gotthelf
Mobile 0152 / 22 88 70 93
dominik.gotthelf@roehm.biz

Richard Sedlak
Tel 0 70 21 / 94 98 970
Mobile 0152 / 22 88 70 30
richard.sedlak@roehm.biz

Baden-Wuerttemberg / Rhineland-Palatinate / Saarland:

Michael Schmitz
Tel 00 33 3 88 72 04 03
Mobile 0152 / 22 88 70 18
michael.schmitz@roehm.biz

Baden-Wuerttemberg / Bavaria:

Dirk Gaarz
Mobile 0152 / 22 88 71 16
dirk.gaarz@roehm.biz

Bavaria:

Jan Birkholz
Mobile 0152 / 22 88 70 14
jan.birkholz@roehm.biz

Gerhard Häutle
Tel 0 90 71 / 7 29 93 22
Mobile 0152 / 22 88 70 15
gerhard.haetle@roehm.biz

Christian Heigl
Mobile 0152 / 22 88 70 26
christian.heigl@roehm.biz

Bavaria / Thuringia:

Steffen Blatz
Mobile 0152 / 22 88 70 16
steffen.blatz@roehm.biz

North Rhine-Westphalia / Rhineland-Palatinate

Ralf Schnichels
Tel 0 21 52 / 8 97 35 47
Mobile 0152 / 22 88 70 25
ralf.schnichels@roehm.biz

North Rhine-Westphalia:

Friedhelm Schneider
Tel 0 27 62 / 49 07 28
Mobile 0152 / 22 88 70 17
friedhelm.schneider@roehm.biz

North Rhine-Westphalia / Lower Saxony

Thorsten Nolte
Tel 0 27 21 / 12 01 82
Mobile 0152 / 22 88 70 31
thorsten.nolte@roehm.biz

Lower Saxony / Saxony

Susanne Bormann
Mobile 0152 / 22 88 70 88
susanne.bormann@roehm.biz

Berlin, Mecklenburg-Western Pomerania, Brandenburg, Saxony-Anhalt:

Hendrik Seifert
Tel 0 30 / 70 07 24 59
Mobile 0152 / 22 88 70 32
hendrik.seifert@roehm.biz

Hesse:

Klaus Dieter Hofmann
Tel 0 64 06 / 90 67 40
Mobile 0152 / 22 88 70 29
k.d.hofmann@roehm.biz

Hamburg / Bremen / Schleswig-Holstein / Lower Saxony:

Willi Phillip Hövermann
Mobile 0152 / 22 88 71 48
WilliPhillip.Hoevermann@roehm.biz

Agents worldwide

Algeria:

RÖHM S.A.R.L.
325, rue Paul Langevin
60740 St. Maximin, FRANCE
Tel 0033 / 344 64 10 00
Fax 0033 / 34 64 00 68
fr.roehm@roehm.biz
www.rohm.fr

Argentina:

Himaq S.R.L.,
Venezuela 3652,
1603 Villa Martelli
Prov. Buenos Aires
Tel 00 541 / 147 093 505,
Fax 00 541 / 147 093 472
himaq@himaq.com.ar

Australia:

RÖHM Asia Pacific Pte. Ltd.
8 Ubi Road 2
#07-10 Zervex
Singapore 408538
Tel 0065 - 64 43 77 48
Mobil 0065 - 83 28 89 80
info@sg.roehm.biz
www.sg.roehm.biz

FISHER LAMCO PTY LTD

Tel 0061 1300 838 572
mark.hughes@fisherlamco.com.au

Austria:

Richard Schörkhuber
Lichtenhof 2 b
8511 St. Stefan ob Stainz
Tel 00 43 / 34 63 / 8 15 10
Fax 00 43 / 34 63 / 8 15 60
Mobil 00 43 / 664 / 9 23 77 10
richard.schoerkhuber@roehm.biz

Schachermayer GmbH,

Schachermayer Str. 2
Postfach 3000, 4021 Linz
Tel 00 43 / 732 / 65 99-0
Fax 00 43 / 732 / 65 99 14 44
maschinenmetall@schachermayer.at

Lackner u. Urnitsch GmbH

Bahnhofgürtel 37, 8020 Graz
Tel 00 43 / 316 / 71 14 80-0
Fax 00 43 / 316 / 71 14 80 39
lackner@urnitsch.at

Haberkorn Ulmer GmbH

Hohe Brücke, 6961 Wolfurt
Tel 00 43 / 55 74 / 69 5-0
Fax 00 43 / 55 74 / 69 5-99
nfo.wolfurt@haberkorn.com

Metzler GmbH u. Co. KG

Oberer Paspelsweg 6-8, 6830 Rankweil
Tel. 00 43 / 55 22 / 7 79 63 - 0
Fax 00 43 / 55 22 / 7 79 63 - 6
office@metzler.at

Belarus:

RÖHM GmbH
Heinrich-Röhm-Straße 50
89567 Sontheim (Germany)
Tel 0049 73 25 - 16 0
info@roehm.biz
www.roehm.ru

Belgium:

RÖHM S.A.R.L.
325, rue Paul Langevin
60740 St. Maximin, FRANCE
Tel 0032 495 72 73 99
Fax 0032 42 86 69 48
frederik.hamels@roehm.biz
www.rohm.fr

BELTRACY

Bergensesteenweg 189
1600 Sint-Pieters-Leeuw
BELGIUM
Tel. 00 32 / 25 43 68 90
Fax 00 32 / 25 38 59 10
info@beltracy.be
www.beltracy.be

Canada:

RÖHM Products of America
2500 Northlake Drive, 30024 Suwanee, GA
Tel 001 - 770 - 963 - 8440
Fax 001 - 770 - 963 - 8407
rohmsa@roehm.biz
www.us.roehm.biz

Chile:

Robert Kralemann
SERVICOMP Ltda.
Av. Departamental 1595
La Florida - Santiago
Tel 00 56 / 2 / 8 89 47 00
rkralemann@gmail.com

Colombia:

RÖHM IND. E COM. DE
FERRAMENTAS DE FIXAÇÃO LTDA.
Rod. Raposo Tavares, Km 14 - Bloco A
2º andar - sala 2 - CEP 05576-100
São Paulo
Tel 0055 - 11 - 37 32 22 22
Fax 0055 - 11 - 37 35 30 97
vendas@rohm.com.br
www.br.roehm.biz

Costa Rica:

RÖHM IND. E COM. DE
FERRAMENTAS DE FIXAÇÃO LTDA.
Rod. Raposo Tavares, Km 14 - Bloco A
2º andar - sala 2 - CEP 05576-100
São Paulo
Tel 0055 - 11 - 37 32 22 22
Fax 0055 - 11 - 37 35 30 97
vendas@rohm.com.br
www.br.roehm.biz

Croatia:

PFEIFER - TTI D.O.O.
40000 Cakovec, Croatia
Tel 00 385-9/ 83 03 52 2
Fax 00 385-1/ 36 39 53 0
marijan.pfeifer@pfeifer-tti.hr

Denmark:

Ryttergaard Tools A/S
Falkevej 13
3400 Hillerød
Dänemark
+45 36 41 22 66
info@ryttergaard.com

Ecuador:

RÖHM IND. E COM. DE
FERRAMENTAS DE FIXAÇÃO LTDA.
Rod. Raposo Tavares, Km 14 - Bloco A
2º andar - sala 2 - CEP 05576-100
São Paulo
Tel 0055 - 11 - 37 32 22 22
Fax 0055 - 11 - 37 35 30 97
vendas@rohm.com.br
www.br.roehm.biz

Egypt:

Dirk Jaegemann Trade Agency
GmbH&Co.KG
28279 Bremen
Tel 0049 / 42 18 39 21 30
Fax 00 49 / 42 18 39 89 21
info@djta.de

Finland:

Teräskonttori Oy,
Muuntotie 3,
1510 Vantaa
Tel 00 358 / 10 219 22 00
Fax 00 358 / 10 219 22 45
info@teraskonttori.fi

Oy Interfil Ltd.

Teollisuuskatu 35-39 LH4
20520 Turku, Y-tunnus 2374026-3
Tel 00 358 / 2 01 47 45 00
Fax 00 358 / 2 01 47 45 01
info@interfil.com

Greece:

K.S.PAPADOPOULOS & CO
Ethnikis Antistaseos Str. 7-A
55134 Thessaloniki - Greece
Tel 0030 2310 488758
Fax 0030 2310 488753
stefanos@agent.com.gr
ntinos@agent.com.gr

India:

RÖHM Asia Pacific Pte. Ltd.
8 Ubi Road 2
#07-10 Zervex
Singapore 408538
Tel 0065 - 64 43 77 48
Mobil 0065 - 83 28 89 80
info@sg.roehm.biz
www.sg.roehm.biz

Indonesia:

RÖHM Asia Pacific Pte. Ltd.
8 Ubi Road 2
#07-10 Zervex
Singapore 408538
Tel 0065 - 64 43 77 48
Mobil 0065 - 83 28 89 80
info@sg.roehm.biz
www.sg.roehm.biz

PT. Germantara Tooling Service Indonesia

Jl. Raya Bekasi Km. 21
Pulogadung Trade Centre (PTC) Blok 8A/B
Jakarta 13920 - Indonesia
Tel. +62 21 46834110
Mobile +62 811 9593027
kris@group.gts.co.id
www.gts.co.id

PT. SOMAGEDE INDONESIA

Komplek Griya Inti Sentosa
Jl. Griya Agung No. 3
Sunter Agung, Jakarta 14350 - Indonesia
Tel. +62 21 6410730
avi@somagede.com
www.somagede.com

Iran:

Sakht Abzar Pars Co. (SAP)
No. 19/4 Saeb Tabrizi St.,
North Abbas Shirazi Ave.,
Molla Sadra Ave., Tehran post code 19917
Tel. 00 98 / 21 / 88 03 18 88
Fax 00 98 / 21 / 88 03 77 33
sales@sap-iran.com

Ireland:

RÖHM (Great Britain) LTD.
Unit 12 the ashway centre
Elm crescent Kingston-upon-Thames
Surrey KT 2 6 HH
Tel 0044 - 20 85 49 66 47
Fax 0044 - 20 85 41 17 83
rohmbg@roehm.biz
www.uk.roehm.biz

Iceland:

Fossberg Ltd.
Dugguvogvi 6, 104 Reykjavik
Tel. 00 354 / 57 57 606
E-mail: fossberg@fossberg.is

Israel:

ETMOS Tool Distributing Co. Ltd.
34 HAHOFER ST., 5811702 Holon
Tel. 00 972 - 3 / 55 81 933
Fax 00 972 - 3 / 55 81 934
etmos@etmos.co.il

Japan:

RÖHM Asia Pacific Pte. Ltd.
8 Ubi Road 2
#07-10 Zervex
Singapore 408538
Tel 0065 - 64 43 77 48
Mobil 0065 - 83 28 89 80
info@sg.roehm.biz
www.sg.roehm.biz

Takeda Trade Co., Ltd.

NAKANOSHIMA DAI-BUILDING 603, 3-3-23,
NAKANOSHIMA, KITA-KU
530-6106 OSAKA
Tel. 00 81 3 6806 0757
hata@takeda-trade.co.jp

Luxemburg:

RÖHM S.A.R.L.
325 rue Paul Langevin
60740 St. Maximin, FRANCE
Tel 00 33 / 3 44 64 10 00
Fax 00 33 / 3 44 64 00 68
fr.roehm@roehm.biz

Malaysia:

RÖHM Asia Pacific Pte. Ltd.
8 Ubi Road 2
#07-10 Zervex
Singapore 408538
Tel 0065 - 64 43 77 48
Mobil 0065 - 83 28 89 80
info@sg.roehm.biz
www.sg.roehm.biz

KS Precision Tools (M) SDN. BHD.

A1-01-05, 1st Floor, Jalan SR 1/9
Taman Serdang Raya, Section 9,
43300 Seri Kembangan
Selangor Darul Ehsan, Malaysia
Tel. 603-8941 7168
michael@ks-precision.com



Agents worldwide

Marocco:

RÖHM S.A.R.L.
325, rue Paul Langevin
60740 St. Maximin, FRANCE
Tel 0033 / 344 64 10 00
Fax 0033 / 34 64 00 68
fr.roehm@roehm.biz
www.rohm.fr

New Zealand:

RÖHM Asia Pacific Pte. Ltd.
8 Ubi Road 2
#07-10 Zervex
Singapore 408538
Tel 0065 – 64 43 77 48
Mobil 0065 – 83 28 89 80
info@sg.roehm.biz
www.sg.roehm.biz

Trade Tools Ltd

23 Olive Road, Penrose
PO Box 112114
Auckland 1642, New Zealand
Tel 0064 9 525 88 82
sales@tradetools.co.nz

Netherlands:

Boorwerk B.V.,
Flevolaan 52 A,
Industrieterriën Noord
1382 JZ Weesp
Tel 00 31 / 294 / 43 20 50
Fax 00 31 / 294 / 43 21 52
mail@boorwerk.nl

RÖHM S.A.R.L.

325 rue Paul Langevin
BP 90204
F-60744 Saint Maximin cedex
Tel 0033 – 344 64 10 00
Fax 0033 – 344 64 00 68
fr.roehm@roehm.biz
www.rohm.fr

Norway:

Ing. Yngve Ege A/S
Ryenstubbën 5
0679 Oslo 11
Tel 00 47 / 23 24 10 00
Fax 00 47 / 23 24 1001
ege@ege.no

Peru:

RÖHM IND. E COM. DE
FERRAMENTAS DE FIXAÇÃO LTDA.
Rod. Raposo Tavares, Km 14 - Bloco A
2º andar - sala 2 - CEP 05576-100
São Paulo
Tel 0055 – 11 – 37 32 22 22
Fax 0055 – 11 – 37 35 30 97
vendas@rohm.com.br
www.br.roehm.biz

Philippines:

RÖHM Asia Pacific Pte. Ltd.
8 Ubi Road 2
#07-10 Zervex
Singapore 408538
Tel 0065 – 64 43 77 48
Mobil 0065 – 83 28 89 80
info@sg.roehm.biz
www.sg.roehm.biz

Nicklaus Machinery Corporation

1795 Malabon Street
Sta. Cruz, Manila 1014 Philippines
Tel. +63 2 7118414
Mobil +63 917 8278812
nmcservice@yahoo.com
www.nicklaus-machinery.com

Romania:

KSN Technik Srl
Str. Tabacarilor 15B/103
400139 CLUJ-NAPOCA, Romania
Tel 00 40 / 264 / 449 - 533
Fax 00 40 / 264 / 449 - 533
office@ksntechnik.ro

Russia:

RÖHM GmbH
Heinrich-Röhm-Straße 50
89567 Sontheim (Germany)
Tel 0049 73 25 – 16 0
info@roehm.biz
www.roehm.ru

Saudi Arabia, UAE, Bahrain, Kuwait, Oman, Qatar, Kazakhstan, Lebanon:

RÖHM Asia Pacific Pte. Ltd.
8 Ubi Road 2
#07-10 Zervex
Singapore 408538
Tel 0065 – 64 43 77 48
Mobil 0065 – 83 28 89 80
info@sg.roehm.biz
www.sg.roehm.biz

COBALT ME FZE

SAIF ZONE
QI-05-077/C
Sharjah, VAE
Tel. +971 5568 34422
sales@cobalt-me.com

Sweden:

Techpoint Systemteknik AB
Nyponvaegen 4
19144 Sollentuna
Tel 00 46 / 86 23 13 30
Fax 00 46 / 86 23 13 45
info@techpoint.se

Luna AB

Sandbergsvägen 3,
44180 Alingsås
Tel. 00 46 / 322 60 60 00
Fax 00 46 / 322 60 62 03
info@luna.se

Singapore:

RÖHM Asia Pacific Pte. Ltd.
8 Ubi Road 2
#07-10 Zervex
Singapore 408538
Tel 0065 – 64 43 77 48
Mobil 0065 – 83 28 89 80
info@sg.roehm.biz
www.sg.roehm.biz

GP System Singapur PTE LTD

No. 51, Bukit Batok Crescent,
#04-04/05 Unity Centre,
Singapur 658077
Tel. 00 65 / 68 61 - 26 63
Fax 00 65 / 68 61 - 35 00
enquiry@gpsystem.com

Slovenia:

B T S COMPANY TRGOVINA IN
FERRAMENTAS DE FIXAÇÃO LTDA.
Bratislavka 5
1000 Ljubljana
Tel 00 38 / 6 1 584 14 40
masa.bitenc@bts-company.si

South Africa:

Supra Tooling and Accessoires (Pty) Ltd
P.O. Box 1892
1460 Boksburg, Gauteng
South Africa
Tel. 0027 6467 4284
Fax 0027 11918 5492
supratoolig@mweb.co.za
www.supratooling.co.za

Tooling Promotions

P.O. Box 3989
Vanderbijlpark 1900, Gauteng
South Africa
Tel 0027 016 931 1266
Fax 0027 016 931 1269
info@toolingpromotions.co.za
www.toolingpromotions.co.za

South Korea:

RÖHM Asia Pacific Pte. Ltd.
8 Ubi Road 2
#07-10 Zervex
Singapore 408538
Tel 0065 – 64 43 77 48
Mobil 0065 – 83 28 89 80
info@sg.roehm.biz
www.sg.roehm.biz

CHEONG DO MACHINE TOOL CO., LTD.

RM A-6-103, 604-1, KURO-DONG
KURO-KU, SEOUL, KOREA
Tel + 82 2 2678 4155
cdmt@chol.com
www.cdmt.co.kr

KMC Co., Ltd.

Zip code 15090
42-404, 204, Gongdan 1-daero,
Siheung-si, Gyeonggi-do, Korea
Tel +82 31 430 67 89
chelee@naver.com
www.entkr.com

Thailand:

RÖHM Asia Pacific Pte. Ltd.
8 Ubi Road 2
#07-10 Zervex
Singapore 408538
Tel. 0065 – 64 43 77 48
Mobil 0065 – 83 28 89 80
info@sg.roehm.biz
www.sg.roehm.biz

Krasstec Company Limited

1205 Rama9 Soi 55, Rama 9 Rd,
Suan Luang, Suan Luang
Bangkok 10250 Thailand
Tel 66 (0)2 732 1144
Mobile 66 (0) 81 941 0509
chaitat@krasstec.com

Tunisia:

RÖHM S.A.R.L.,
325 rue Paul Langevin
60740 St. Maximin, FRANCE
Tel. 00 33 / 3 44 64 10 00
Fax 00 33 / 3 44 64 00 68
fr.roehm@roehm.biz

Turkey:

Sintek Mühendislik Makina San.
Ve Tic. Ltd. Sti.
Tarabya Mahallesi
Yumak Sok. No: 3/A1
34457 SARIYER – İSTANBUL
Tel. 00 90 / 212 / 2 99 61 84
Fax 00 90 / 212 / 2 99 56 75
sinan.onurlu@sintekmuhendislik.com

Ukraine:

Denis Alexandrov
Official Sales Consultant Russia
on behalf of RÖHM GmbH
Tel. +7 985 110 12 34
denis.alexandrov.external@roehm.biz
www.roehm.ru

Venezuela:

RÖHM IND. E COM. DE
FERRAMENTAS DE FIXAÇÃO LTDA.
Rod. Raposo Tavares, Km 14 - Bloco A
2º andar - sala 2 - CEP 05576-100
São Paulo
Tel 0055 – 11 – 37 32 22 22
Fax 0055 – 11 – 37 35 30 97
vendas@rohm.com.br
www.br.roehm.biz

Vietnam:

RÖHM Asia Pacific Pte. Ltd.
8 Ubi Road 2
#07-10 Zervex
Singapore 408538
Tel 0065 – 64 43 77 48
Mobil 0065 – 83 28 89 80
info@sg.roehm.biz
www.sg.roehm.biz

CUONG ANH MACHINERY CO., LTD

2/27 Hoang Nhu Tiep, Bo De.
Long Bien, Hanoi, Vietnam
Hanoi Office: Suite 1005 - B. HH2B
Building, Gia Thuy Street, Long Bien
District, Hanoi, Vietnam
+ 84 24 3872 3571
Ho Chi Minh City Office:
Suite 501, No 67 Pho Quang Street, 2 Ward,
Tan Binh District, Ho Chi Minh City, Vietnam
Tel 0283 547 0769
contact@cuonganhvn.com
www.cuonganhvn.com

General Terms of Sale and Delivery

§ 1 Offer, conclusion of contract and contractual contents

1. Our Terms of Sale shall apply exclusively; we do not recognise contradictory terms and conditions or terms and conditions which deviate from our Terms of Sale unless we had explicitly approved their validity in writing. Our Terms of Sale shall also apply if we carry out the delivery to the buyer without reservation in the knowledge of contradictory terms and conditions of the buyer or terms and conditions which deviate from our Terms of Sale.
2. Our Terms of Sale shall only apply towards an entrepreneur within the meaning of Section 14 BGB [German Civil Code].
3. Our General Service Terms shall apply with precedence over these Terms of Sale in the respective valid version in cases, which comprise the service offer of RÖHM GmbH.
4. Our offers are always to be understood as invitatio ad offerendum and are therefore without obligation insofar as they have not explicitly been described as binding. The contract shall only be concluded with our written confirmation and in line with its contents and – if a written confirmation is missing – by the service/delivery. If a delivery/service is carried out immediately without a confirmation then the invoice shall at the same time be deemed as an order confirmation.
5. Costs for the production of drawings for special constructions are to be borne by the orderer insofar as the offer does not lead to an order for reasons, for which we are not responsible.
6. All details concerning weights, dimensions, services and technical data, which are contained in our printed material, catalogues, price lists or in other contractual documents, merely serve for purposes of information and are only binding insofar as they are explicitly described as binding.
7. We reserve the right to make construction and form changes to the object of contract insofar as no changes are made hereto, which are deemed unreasonable for the orderer.
8. The documentation consists of the compilation drawing, the BOM with marking of the parts subject to wear and tear and spare parts as well as assembly instructions upon request. Respectively in German and/or, upon request, in English. This free documentation will be supplied in a digital form. The PDF format shall apply to drawings, BOMs and texts. Any scope of documentation beyond this is liable to costs respectively requires a special agreement. The documents may not be reproduced in full or in part, not made accessible to third parties or used for any other purpose apart from that for which they were handed over to the customer without our prior written authorization.
9. The corresponding measurement methods for tests, with which certain temperatures, times and other measured or control values should apply, must be stipulated before start of delivery and recognised by both parties. If no stipulation is made the measurement methods usually applied by RÖHM shall apply, we shall provide the details thereof upon request.
10. Samples will only be supplied against payment and owing to a separately placed order.
11. Assurances, collateral agreements and amendments to the contract require a written form in order to be valid. This requirement cannot be waived orally.
12. Placed orders are irrevocable unless the supplier has approved the revocation in writing.
13. In case of export business the delivery is carried out at the conditions agreed on the order confirmation, the international regulations for the interpretation of customary contractual forms shall apply in addition (incoterms 2010 of the International Chamber of Commerce, respective valid status).
14. Our General Business Terms shall apply to the RÖHM online shop with the following supplementations:
 - a) The offer on the part of the customer is submitted binding as soon as the customer orders the products in the shopping basket by using the function „binding order“.
 - b) A purchase in the online shop is only possible if the customer actively agrees to our General Business Terms.
 - c) Mistakes and errors with regard to the goods availability, prices and other details and data excepted. Diagrams in the online shop are merely for the purpose of illustration respectively as visual aids; the description is binding.
 - d) We will inform the customer if the product ordered by the customer is temporarily or permanently not available.
15. Our „product information“, technical information leaflets as well as other product-specific publications shall apply in addition to the General Business Terms. These are always to be compiled with in their current version.

§ 2 Prices

1. In the absence of special written agreements the prices in the Federal Republic of Germany shall apply „carriage paid“ recipient plus the statutory value added tax. With export business the object of delivery shall be deemed as sold „ex works“ if nothing is determined in the contract concerning the type of sale. A processing fee of EUR 15.00 will be charged for individual orders with a goods value of less than EUR 150.00 net, a processing fee of EUR 30.00 for orders with a goods value of less than EUR 50.00 net respectively plus the applicable rate of value added tax. This shall apply to deliveries within the domestic country and overseas. At the customer's request the goods can be delivered to an alternative shipping address against a logistics fee in the amount of EUR 10.00.
2. We would like to point out that we will only carry out the shipment at the customer's request. This shall have no effect on the regulations according to Section 5.
3. We shall charge the prices valid upon conclusion of the contract, which are based on the cost factors which are valid at this time. Should these cost factors (in particular material, wages, energy, etc.) change between conclusion of the contract and the agreed delivery time then we are entitled to make a corresponding change to the prices. In case of export business the supplier is entitled to terminate the contract extraordinarily with regard to the part of the order that has not yet been completed or to adjust the prices for this accordingly in the event of a substantial devaluation in the currency, in which the order is concluded.
4. In case of conclusion ex works the goods will be conveyed at the costs and risk of the orderer. With all other consignments the provisions stipulated in the incoterms 2010, respective valid status, will apply with regard to insurance and the assumption of risks.
5. We will inform the buyer of our production quantity for parts/products, which are produced especially according to the buyer's requests. The buyer undertakes to purchase the quantities confirmed to him.
6. Excess and shortfalls in deliveries of up to 5 %, with special tools up to 10 %, at least however 2 pieces, are permitted and do not substantiate any quality defects. The respective delivery will be charged.

§ 3 Terms of payment

1. In the absence of a special agreement the payment is to be made without any deduction free paying agent within 10 days after the invoice date – also with partial deliveries.
2. In case of default of payment interest will be charged in the amount of the credit costs charged by banks, at least however interest in the amount of 9 % above the respective base lending rate of the ECB.
3. In case of export business the payments are to be made in line with the agreed terms of payment.
4. Costs of the payment transactions, in particular bank charges for overseas transfers to us, shall principally be for the expense of the customer.

§ 4 Delivery time

1. The start of the delivery deadline stated by us presumes the clarification of all technical questions. Delivery dates stated by us are – insofar as not explicitly agreed or described as binding – non-binding and shall merely represent an expected delivery date.
2. The compliance with our delivery obligation further presumes the timely and proper fulfillment of the buyer's obligations, in particular the compliance with the agreed terms of payment. The right is reserved to the plea of the unfulfilled contract. This right shall also consist of obligations from previous deliveries which have not been satisfied in full.
3. The delivery deadline shall begin with the sending of the order confirmation, however not before the provision of the documents, permit, releases, etc., which are to be procured by the orderer, as well as not before the receipt of the agreed down payment.
4. If a binding delivery date has been agreed then the supplier also has to deliver within the deadline. The delivery deadline shall have been adhered to if the object of delivery has left the plant by the time it expires or notification has been given that the object is ready for delivery, the right is reserved to the timely and correct self-delivery. If the orderer changes his order with regard to parts of the delivery then the delivery deadline shall only begin to apply new again with the confirmation of the change.
5. Force majeure, war, civil commotion, strike, lock-out or measures of authorities, no matter for what reason, which oppose a delivery, as well as deficiencies of raw materials, of transport means as well as theft – also at the sub-suppliers – shall release the supplier from the obligation to deliver within the agreed deadline. The orderer is to be notified immediately of the occurrence of the event and of the expected implications.
6. Deliveries before expiry of the delivery time and in reasonable parts are permitted.
7. The adherence to the delivery time presumes the fulfillment of the orderer's contractual obligations.
8. The regulations of Subclause 10 shall apply in the event of the delay in delivery or impossibility.

§ 5 Passing of risk and acceptance

1. The risk shall pass to the orderer by no later than with the despatch of the delivered parts also if partial deliveries are made or we have taken over other services e.g. the shipping costs or delivery to the location and installation.
2. At the orderer's request the shipment shall be insured by us against theft, damages caused by breakage, transport, fire and water and other insurable risks at his costs.
3. If the shipment is delayed as a result of circumstances, for which the orderer is responsible, then the risk shall pass to the orderer from the day upon which the goods are ready for shipment; however we are obliged to procure the insurances, which he requests, at the request and costs of the orderer.
4. Delivered objects are, even if they feature insignificant features, to be accepted by the orderer irrespective of the rights from Section 8.

§ 6 Delay in acceptance, order on call

1. If the orderer does not accept the object of contract within the deadline we are entitled to set him a reasonable final deadline, to dispose otherwise over the object after its expiry and to supply the orderer with a reasonably extended deadline. Our rights to cancel the contract under the pre-requisites of Section 326 BGB and to request damages owing to the non-fulfilment shall remain unaffected hereby. If we request damages owing to non-fulfilment we can request 40 % of the agreed price plus value added tax as compensation unless the orderer proves less damages. We reserve the right to assert higher actual damages.
2. Orders, which are confirmed by us on call, must – insofar as nothing special has been agreed – be accepted by no later than within one year from the order date. The same shall apply in case of date reservations or sustainable „on call position“. Subclause 6.1 shall apply accordingly in case the goods are not called within the stated deadline.

§ 7 Reservation of title

1. The objects of the deliveries (reserved goods) shall remain our property until the fulfillment of all claims to which we are entitled against the buyer from the business relationship. Insofar as the value of all security rights, to which we are entitled against the buyer, exceed the amount of all secured claims by more than 10 %, we will release a corresponding part of the security rights at the buyer's request.
2. During the existence of the reservation of title the buyer is prohibited from a pledge or assignment as collateral and the resale only permitted for resellers in the customary course of business and only under the condition that the reseller receives a payment from his customer or stipulates the reservation that the property shall only pass to the customer when he has satisfied his payment obligations.
3. In case of attachments, seizures or other disposals or interventions of third parties the buyer has to inform us immediately so that we can file an action according to Section 771 ZPO [German Code of Civil Procedure]. Insofar as the third party is not in the position to reimburse us the court and out-of-court costs of an action according to Section 771 ZPO, the buyer will be liable for the loss incurred to us.
4. The buyer undertakes to treat the object of purchase with due care and attention; he is in particular obliged to sufficiently insure these at the value as new at his own costs against damages caused by fire, water and theft. Insofar as maintenance and inspection work is necessary the buyer must carry this out in time at his own costs.

General Terms of Sale and Delivery

5. In case of breaches of duty by the buyer, in particular with default of payment we are entitled to cancellation and to take the goods back; the buyer is obliged to hand the goods over. The taking back of goods respectively the assertion of the reservation of title does not require any cancellation of the supplier; these acts or an attachment of the reserved goods by us shall not represent a cancellation of the contract unless we had explicitly declared this.

6. If the buyer has resold the object of purchase in the ordinary course of business then he shall hereby now already assign all claims to us in the amount of the final invoice amount (including value added tax) of our claim, to which he is entitled from the resale against his buyers or third parties, irrespective of whether the object of purchase has been resold without or after processing. The buyer shall also remain authorized to collect this claim after the assignment. Our authorization to collect the claim ourselves shall remain unaffected hereby. However, we undertake not to collect the claim as long as the buyer satisfies his payment obligations from the collected proceedings, is not in default of payment and in particular no application has been filed for the opening of insolvency proceedings or payments have been suspended. If this is however the case we can request that the buyer announces the assigned claims and their debtors to us, provides us all details which are necessary for the collection, hands over the associated documents and informs the debtors (third parties) of the assignment.

7. The processing or conversion of the object of purchase by the buyer is always carried out on our behalf. If the object of purchase is processed with other objects, which do not belong to us, then we shall acquire the co-ownership to the new object in the ratio of the value of the object of purchase (end invoice amount, including value added tax) to the other processed objects at the time of the processing. Incidentally, the same shall apply to the object produced by processing as to the object of purchase delivered under reservation.

8. If the object of purchase is inseparably mixed with other objects that do not belong to us then we shall acquire the co-ownership to the new object in the ratio of the value of the object of purchase (end invoice amount, including value added tax) to the other mixed objects at the time of the mixing. If the mixing is carried out to the extent that the object of the buyer is to be seen as the main object then it shall be deemed as agreed that the buyer assigns us the pro rata co-ownership. The buyer shall store the thus produced sole ownership or co-ownership on our behalf.

§ 8 Quality defects

We shall be liable for quality defects as follows:

1. All those parts or services are to be subsequently improved free of charge at our choice, delivered or provided new, which – irrespective of the operating duration – feature a quality defect if this cause existed already at the time when the risk was passed.

2. Claims for quality defects shall become statute-barred in 12 months. The deadline will begin with the passing of the risk (Subclause 6).

3. The buyer has to report quality defects to us immediately in writing.

4. In case of reports of defects payments of the buyer may be withheld in a scope, which is in reasonable relation to the occurred quality defects. If the defect is unjustifiably reported we are entitled to request reimbursement of the expenses incurred to us by the buyer.

5. We are first of all always to be granted the opportunity for the subsequent fulfillment within a reasonable period of time.

6. If the subsequent fulfillment fails the buyer can – irrespective of possible claims for damages – cancel the contract or reduce the remuneration. The buyer can only request reimbursement for fruitless expenses if we are responsible for the defect owing to wilful intent or gross negligence.

7. Defects shall not exist with an only insignificant deviation from the agreed conditions, with an only insignificant impairment to the usability, with natural wear and tear or damages, which are caused after the risk has passed as a result of faulty or negligent treatment, excessive use, unsuitable operating equipment or owing to special external influences, which are not presumed according to the contract, as well as with software faults that cannot be reproduced. If improper changes or repair work is carried out by the buyer or by third parties then this and the thus incurred consequences shall not substantiate any defects either. The same shall apply if our stipulations concerning the handling and other instructions are not complied with and a proper maintenance is not carried out.

8. Claims of the buyer owing to the expenses, which are necessary for the purpose of the subsequent fulfillment, in particular transport, route, labour and material costs, are excluded if the expenses increase, because the object of the delivery has subsequently been taken to another location than the buyer's branch unless the transportation corresponds with its use as intended.

9. Statutory claims for recourse of the buyer against us shall only exist to the extent that the buyer has not reached any agreements with its buyer that go beyond the statutory claims for defects.

10. Subclause 9 shall apply to claims for damages. Further or other than claims regulated in this Subclause or in Subclause 9 owing to a quality defect are excluded.

§ 9 Industrial property rights and copyrights, defects of title

Insofar as not otherwise agreed, we are obliged to merely provide the delivery in the country of the place of delivery free of industrial property rights and copyrights of third parties (hereinafter property rights). Insofar as a third party asserts justified claims owing to the infringement of property rights due to deliveries provided by us and used as per contract against the buyer, we shall be liable towards the buyer as follows within the deadline determined in Subclause 8.2:

1. We will, at our choice and at our costs, either obtain a right of use for the deliveries concerned, change these so that the property right is not infringed, or exchange these. If this is not possible for us at reasonable conditions, the buyer shall be entitled to the statutory rights to cancellation or reduction. The buyer can only request reimbursement for fruitless expenses if we are responsible for wilful intent or gross negligence. Our obligation to pay compensation is oriented to Subclause 10.

2. The afore-mentioned obligations shall only exist if the buyer informs us immediately in writing about the claims asserted by third parties, does not recognise an infringement and we reserve the right to all defence measures and settlement negotiations. If the buyer discontinues the use of the delivery for reasons to minimise damages or for other important reasons he undertakes to inform the third party that the discontinuation of the use is not associated with a recognition of an infringement of a property right.

3. Claims of the buyer are excluded insofar as he is responsible for the infringement of property right.

4. Claims of the buyer are further excluded insofar as the infringement of property right is caused by special stipulations of the buyer, due to an application that is not foreseeable for us or by the fact that the delivery is changed by the buyer or is used together with products not delivered by us.

5. In the event of infringements of property rights the provisions of Subclauses 8.4, 8.5 and 8.9 shall apply accordingly to the claims of the buyer regulated in Subclause 13.

6. Further or other claims of the buyer against us or our vicarious agents owing to a defect of title than those regulated in this Subclause 9 are excluded.

§ 10 Joint and several liability

1. Claims of the buyer for damages – irrespective of the legal nature of the asserted claim – are excluded.

2. Excluded from this are:

a) Damages owing to the breach of essential contractual obligations. Deemed as essential are such contractual obligations, the fulfilment of which makes the proper execution of the contract possible at all and on the compliance with which the contractual partner may as a rule rely and depend on.

b) Damages from the injury to life, the body or the health if we are responsible for the breach of obligation.

c) For other damages, which are due to a wilful or grossly negligent breach of duty, whereby our breach of duty is deemed equivalent to that of our legal representatives or vicarious agents.

d) Liability according to the ProdHaftG [German Product Liability Act]

3. A change to the burden of proof for the disadvantage of the buyer is not associated with the afore-mentioned regulations.

4. Insofar as the liability for damages is excluded or limited against us, this shall also apply with regard to the personal liability for damages of our employees, our commercial agents and our vicarious agents.

§ 11 Obligations of the buyer to provide assistance

1. Assistance services of the buyer, which are explicitly or tacitly agreed within the framework of the contract, shall be carried out without a special remuneration unless explicitly otherwise agreed.

2. The buyer is obliged to inform us about all facts in time, from which it can be derived that goods and products in stock in our company, which we have made available with regard to the production capacities reported to us, cannot be used or not used in full. If residual stocks remain the buyer shall take over the stocks and the, if applicable incurred destruction costs in the event of a premature change to its material scheduling. This shall also apply to products, with which we had to order minimum quantities on the part of our suppliers if we have informed the customer hereof in advance.

3. The buyer guarantees that the products supplied by him for processing are suitable for this purpose. We are not obliged to examine the products supplied by the buyer for the condition and the suitability for the further processing. Within the framework of ongoing business relationships as well as if an object for processing has initially been inspected, tested and released, the buyer undertakes to inform us of each product change without request in writing. In the case of regular processing of objects the buyer is further obliged to examine the object that is to be processed by us for deviations and changes for each change to the production conditions and in his company, in particular with the exchange of tools, machines or with the introduction of new production processes and to notify us of such changes and modifications in writing.

4. We do not have to examine the instructions of our buyers, the material selection or other regulations, which are made by our buyer, for their accuracy.

5. Therefore, the buyer has to examine all instructions, which he issues as well as the quality of the materials stipulated or made available to us for the compliance with the statutory and technical regulations.

6. If the buyer is in default with regard to his obligation for provision or to provide assistance after a written warning we are entitled to the statutory rights.

7. Goods may only be returned with the supplier's express permission. Any returned goods must be delivered free in their original packaging and must be accompanied by the return receipt provided by the supplier. The goods must be in their original state, i.e. undamaged and fully functional. Returned goods will no longer be accepted when six months have lapsed from the date of delivery. Returns of specially designed or custom-made items, as well as used goods will not be accepted. We will charge a handling fee of 20 % - 40 % of the value of the goods, however, at least EUR 100 per item plus statutory VAT. Following presentation of appropriate evidence, the supplier reserves the right to charge a higher amount to the purchaser in individual cases; the purchaser is free to prove that the damage was lower.

§ 12 Place of performance and place of jurisdiction/miscellaneous

1. The place of performance and place of payment is the registered seat of our company in Sontheim/Brenz.

2. The law of the Federal Republic of Germany is to be exclusively applied to the contractual relationship. The application of the Convention of the United Nations of 11 April 1980 concerning Contracts for the International Sale of Goods (CISG „Law governing the sale of goods of Vienna“) is excluded.

3. With all disputes ensuing from the contractual relationship, if the orderer is a merchant, a legal entity under public law or a special fund under public law, the action is to be filed at the court that has jurisdiction for our headquarters. We are also entitled to file action at the headquarters of the orderer.

4. We store your data according to Section 23 Federal Data Protection Act.

RÖHM GmbH

89565 Sontheim (Germany)

Status: July 2019

General Service Terms (ASB) of RÖHM GmbH, Sontheim

1. Validity

1.1 These ASB form the basis for all business transactions with our customers, which refer to the repair or maintenance of the products manufactured or delivered by us insofar as these customers concern entrepreneurs within the meaning of Section 14 BGB [German Civil Code].

1.2 Contradictory, supplementary contractual terms and conditions of the customer or those which deviate from these ASB will not be recognised.

1.3 Within the framework of a regular business relationship these ASB will also be valid after the effective inclusion for the first time if we do not explicitly refer hereto in follow-up transactions.

1.4 Insofar as the ASB do not include any regulations, the General Terms of Sale and Delivery of RÖHM GmbH shall apply.

2. Offer and conclusion of the contract

2.1 Our offers are – insofar as not explicitly marked as binding – without obligation and merely to be understood as invitatio ad offerendum. The right is reserved to an interim sale.

2.2 Contracts with us will only be concluded with our written acceptance declaration or – if such is not carried out – by our delivery and service. Changes and supplementations to the contracts concluded with us require a written form.

2.3 If the object of maintenance or repair was not delivered by us then the customer has to point out existing industrial property rights with regard to the object if we are not responsible for any fault the customer shall indemnify us from possible claims of third parties from industrial property rights.

2.4 Insofar as we are responsible for negligence Par. 2.3 shall apply accordingly.

3. Contractual parts

The offer and the product list respectively available to us and the customer are a part of the contract.

4. Technical documents and plans

4.1 All rights to our offer documents as well as documents, which have been handed over, shall remain reserved.

4.2 The customer shall recognise our rights and will not reproduce the documents in full or in part, not make these accessible to third parties or use these for any other purpose than that for which they were handed over to him without our prior written authorization.

5. Scope of services, maintenance, condition of device, repair

5.1 Decisive for the scope of our delivery and service is our binding offer or – if such is not available – our written declaration of acceptance. Both individual services can be agreed, which are principally to be remunerated according to Subclause 12.1, as well as the service packages described under Subclause 5.2, which are to be remunerated according to 12.2 respectively 12.3.

5.2 The following activities are a part of our service obligation with the processing of service packages:

5.2.1 Commissioning of service

- skilled execution of the necessary commissioning of the clamping device and control at the place of installation in line with the regulations of the manufacturer.
- assembly work over the course of the commissioning together with the machine manufacturer
- first instructions and operator training
- we will invoice separate requests for the training with regard to the maintenance and use as separate work.

5.2.2 Inspection service

Skilled execution of the necessary inspection of the clamping device and control at the place of installation in line with the regulations of the manufacturer. Insofar as additional maintenance or repairs become necessary at the customer's request or owing to special loads, these are to be remunerated separately by the customer.

5.2.3 Maintenance service

Skilled execution of the necessary maintenance of the clamping device and control at the place of installation in line with the regulations of the manufacturer. Insofar as additional repairs become necessary at the customer's request or owing to special loads, these are to be remunerated separately by the customer.

5.3 The service obligation shall begin with the purchase or conclusion of a service package. With the purchase or conclusion of a service package after the expiry of the warranty period the service obligation of RÖHM shall only refer to such products, which are capable of use and free of defects at the time of the conclusion or purchase of the service package. This is to be ensured by an inspection of the products; if defects are determined these are to be remedied before the start of validity of the service package by a necessary repair liable to costs; this repair is not part of the service package.

5.4 Our service obligation shall not include carrying out work on products and accessories, which was(were) not delivered by us.

5.5 Our service obligation shall lapse if the product was not subjected to the function and safety tests according to the details in the operating instructions or third parties have carried out work on the products concerned without our prior written consent unless this work has no disadvantageous influence on the provision of our service. The same shall apply if the products have been damaged due to causes for which we are not responsible, for example by water, fire, stroke of lightning or other implications of force majeure as well as with improper treatment by the customer or third parties.

5.6 Depending on the use and type of the product an overhaul may be necessary after longer use. This is the case if the costs of a repair exceed the current value of the product. Overhaul within this meaning is also the necessary new acquisition of a product in the absence of available spare parts. Overhauls are not part of the service obligation within the service packages. If we are of the opinion that a products that is to be maintained by us under a service package requires an overhaul, we will inform the customer hereof by stating the current value estimated by us and submit an offer for the overhaul to the customer with a remuneration calculated according to 12.1.

6. Repair/service that cannot be carried out

6.1 The services provided concerning the details of a cost estimate as well as the further incurred and to be proven work (fault search time equal to working hours) will be invoiced to the customer if the repair cannot be carried out due to reasons for which RÖHM GmbH is not responsible, in particular because the fault for which a complaint will be made did not occur during the inspection, spare parts cannot be procured, the customer culpably missed the agreed date or the contract was terminated during the execution.

6.2 The object of repair only needs to be restored to the original condition again at the explicit request of the customer against reimbursement of the costs unless the undertaken work was not necessary.

6.3 In case of a repair that cannot be carried out RÖHM GmbH shall not be liable subject to sentence 2 for damages to the object of repair, the breach of contractual secondary obligations and for damages, which were not suffered to the object of repair itself, no matter to which legal grounds the customer refers. RÖHM, on the other hand, will be liable in case of wilful intent, with gross negligence of the owner / the executive bodies or executives as well as with the culpable breach of essential contractual duties. Such contractual obligations are deemed essential, the fulfillment of which makes the proper execution of the contract possible at all and the compliance with which the contractual partner may as a rule rely and depend upon.

7. Duration of the service

7.1 The details with regard to the duration of repairs and services are based upon estimates and merely serve as information and a first estimate by the customer. They are therefore not binding if they have not been explicitly marked as binding.

7.2 In case of subsequently placed additional and extension orders or with necessary additional repair work the agreed repair deadline shall be extended accordingly.

8. Obligations to provide assistance of the customer

8.1 The customer has to draw our attention to the statutory, official and company safety and other regulations applicable at the place of destination of our delivery and service, which refer to the delivery, the assembly and the operation.

8.2 The customer will inform us with or immediately after his order about possible special features of the place of installation, which may have an implication on the proper function of the products, in particular about the structural condition and the concrete operating environment.

8.3 The customer shall ensure – also during the warranty period according to Subclause 17.5 – a regular and skilled maintenance of the products delivered by us insofar as this was not taken over by us as per contract.

8.4 The customer shall dispose of the goods delivered by us at his own responsibility and at his own costs according to the respective valid regulations. We are not obliged to create a possibility for the return unless this would have been stipulated by law.

8.5 The customer has to support the repair / maintenance personnel with the execution of the repair at his own costs.

8.6 The customer has to take the special measures, which are necessary for the protection of persons and objects at the workplace. He also has to inform the repair managers about existing special safety regulations insofar as these are of significance for the repair personnel. He shall inform us in case of breaches of the repair personnel of such safety regulations. In case of serious breaches he can refuse the infringing party access to the repair location by mutual agreement with the repair manager.

8.7 The customer shall bear a supervisory and assistance obligation for the compliance with the statutory working time limits. Breaches are to be reported to RÖHM GmbH.

8.8 The customer is obliged to provide the reasonable and necessary technical assistance at his costs, in particular to:

- a) Provision of the necessary, suitable assistants in the number that is necessary for the repair and for the necessary time; the assistants have to follow the instructions of the repair manager. We do not assume any liability for the assistants. If a defect or damages were caused by the assistants owing to instructions of the repair manager, then the regulations of Sections 17 and 18 shall apply accordingly.
- b) Undertaking of all construction, bedding and scaffolding work including the procurement of the necessary building materials.
- c) Provision of the necessary devices and heavy tools as well as the necessary commodities and required materials.
- d) Provision of heating, lighting, operating power, water, including the necessary connections.
- e) Provision of necessary, dry rooms, which can be locked for the storage of the tool for the repair personnel.
- f) Protection of the repair place and materials against harmful influences of all kinds, cleaning of the repair place.
- g) Provision of suitable, theft-proof recreation rooms and work rooms (with heating, lighting, washing possibility, sanitary facilities) and First Aid for the repair personnel.
- h) Provision of the materials and undertaking of all other acts, which are necessary for the adjustment of the object of repair and for carrying out a testing that is envisaged as per contract.

8.9 The technical assistance of the orderer must guarantee that the service can be started immediately after the arrival of our personnel and carried out without delay until the acceptance by the orderer. Insofar as special plans or instructions of RÖHM are necessary, RÖHM shall make these available to the orderer in time.

9. Obligations of the customer to provide assistance in case of maintenance

9.1 The products are to be used as intended and according to their protection type and in line with the operating instructions together with their annexes.

9.2 In case of an agreement of one of the service packages described in Subclause 5, the customer will place the products that are to be installed, maintained or repaired into a faultless condition, capable of use before conclusion of the contract at his own costs if the products are not already in such a condition. If the customer does not properly satisfy this obligation either after a warning on our part and within the deadline we are entitled to accordingly cancel the contract or the delivery. Further claims for damages on our part shall remain unaffected.

9.3 If the customer uses the maintenance service interferences are to be reported to us immediately in writing, in detail and in an understandable manner.

9.4 Our employees and vicarious agents are to be granted the unimpeded and safe access to the products. In case of delays for which the customer is responsible he is obliged to remunerate the waiting times of our employees and vicarious agents resulting from the delay separately.

9.5 The customer shall refrain from commission third parties with the services during the term of a service agreement, which we have to provide according to the agreement or from performing this work himself.

9.6 The customer has to draw our attention to the statutory, official and company safety regulations and other regulations applicable at the place of destination of our delivery and service, which refer to the delivery, the assembly and the operation.

10. Inspection and acceptance

10.1 Services will be provided by us according to the guidelines of our quality control and deliveries inspected accordingly. If the customer requests further inspections then these are to be agreed in writing and paid by the customer. This shall relate e.g. to special tests for the acceptance.



General Service Terms (ASB) of RÖHM GmbH, Sontheim

10.2 The customer undertakes to accept our services under this contract immediately after the report that they have been completed. Upon request he has to declare their acceptance in writing towards our employees or vicarious agents insofar as there is no essential defect. This is carried out by the signing of the service report.

10.3 Our services shall be deemed as accepted free of defects with the re-commencement of the operational use of the maintained or repaired product, in particular for production purposes, if no defects have been previously reported by the customer.

11. Cost details and cost estimate

11.1 The creation of the cost estimates is liable to costs if the execution of the repair is not approved.

11.2 The costs for a cost estimate amount to the flat rates fixed in the current price list.

11.3 If the repair cannot be carried out at these costs or if our employees or vicarious agents consider the execution of additional work to be necessary during the repair the customer's consent is to be obtained if the stated costs are exceeded by more than 15%.

12. Remuneration, maturity and terms of payment

12.1 Insofar as not otherwise agreed and there is no warranty case our services are to be remunerated according to the actual work requirement pursuant to our respectively valid general price lists. The time required by our employees will be settled in time sections of 15 min. In addition to the time required for the work that is to be performed in these cases the customer will pay the travelling and waiting times, overtime surcharges, expenses, travelling and accommodation costs as well as the costs of spare parts, materials subject to wear and tear and consumables and replacement part sets according to our prices lists or in line with the offer.

12.2 Insofar as a flat rate remuneration was agreed for a service package, our work and travelling costs and expenses are thus covered, not however the costs for waiting times, overtime at the customer's request, spare parts, materials subject to wear and tear and consumables, replacement parts sets as well as other accessories. Our work for if applicable necessary repairs is to be remunerated separately by the customer according to Subclause 12.1.

12.3 The prices for our services can be derived from the respective price list valid upon conclusion of the contract and are deemed ex works plus value added tax. The calculation basis for the remuneration is the one-shift operation, i.e. a use of the products up to 160 hours in a calendar month. A surcharge to the list price of 50% is charged for the two-shift operation, a surcharge of 100% for the three-shift operation. The above two rates shall only apply to the service packages described under Subclause 5. If the customer requests assignments outside of our normal working hours (Mo - Fr, 6:30 am - 6:30 pm, a max. of 7 h per day) surcharges will be calculated according to the respective valid price list.

12.4 If our personnel and material costs are increased then we are entitled to adjust the contractual prices after the expiry of the first year up to a maximum of 5% above the price of the previous year. Price changes will be announced to the customer at least one month before the new contractual prices come into force. The customer is entitled to terminate the contract effective as of the time at which the new price would become valid for him for the first time.

13. Transport and insurance with the repair in the plant of RÖHM GmbH

13.1 The object for repair will be delivered by the customer to us at his costs together with the repair and service form and after execution of the repair collected by the customer again or return to him at the customer's costs.

13.2 The customer shall bear the risk of transport.

13.3 At the customer's request a shipment carried out by us will be insured at the customer's costs against the insurable transport risks, e.g. theft, breakage and fire.

13.4 No insurance cover exists during the repair time in our plant. The customer has to ensure the maintenance of the existing insurance cover for the object of repair e.g. with regard to fire, pipe water, storm and machine breakage insurance. Insurance cover can only be procured for these risks at the explicit wish and costs of the customer.

13.5 In case of delay of the customer with the take-over we can charge a storage fee for the storage in our plant. The object of repair can also be stored otherwise at our discretion. The costs and risk of the storage during the delay shall be for the expense of the customer.

14. Repair deadline

14.1. The details concerning the repair deadlines are based on estimates and merely serve for the purpose of information and first orientation. They are therefore not binding unless this is explicitly agreed.

14.2. The agreement of a binding repair deadline, which must be described as binding, can only be requested by the customer if the scope of the work has been precisely determined.

14.3. The binding repair deadline will have been adhered to if by the time that it expires the object of repair is ready for take-over by the customer, in the event of a contractually envisaged testing ready for its execution.

14.4. In case of subsequently placed additional and extension orders or with necessary additional repair work the agreed repair deadline will be extended accordingly.

14.5. If the repair is delayed due to measures within the scope of industrial disputes, in particular strike and lock-out as well as the occurrence of circumstances, which were not caused by us, a reasonable extension to the repair deadline will occur insofar as such impediments have as proven a substantial influence on the completion of the repair; this shall also apply if such circumstances occur after we are in default.

15. Ban on offsetting and assignment; subcontractors

15.1 The customer is only entitled to offsetting in the event of undisputed claims or claims which have been declared final and binding. This shall not apply if the customer asserts claims in the reciprocal relationship, in particular claims for defects.

15.2 The assignment of rights of the customer from contractual relationships with us presumes our prior consent in order to be valid. This shall not apply insofar as Section 354 a HGB [German Commercial Code] applies.

15.3 We are entitled to use third parties in order to fulfil our contractual obligations.

16. Reservation of title

16.1 The goods delivered by us shall remain our property until the payment of all of our claims against the customer, no matter for what legal grounds, also future ones. In case of current account the afore-mentioned property shall be deemed as security for our balance claim.

16.2 The customer may only sell within the framework of his customary business transactions and neither pledge, nor assign the goods as collateral. The customer hereby

assigns us for security of our payment claims against him, in the amount of the value of our delivery and service, all claims with all secondary rights, which he acquires against his buyer owing to such a sale.

16.3 As long as the property has not yet been assigned, the customer has to inform us immediately in writing if the delivered object is attached or is exposed to other interventions of third parties. Insofar as the third party is not in the position to reimburse us the court and out-of-court costs of an action according to Section 771 ZPO [German Code of Civil Procedure] the customer shall be liable for the loss incurred to us.

16.4. We undertake to release the securities to which we are entitled at the customer's request insofar as their value exceeds the claims which are to be secured by more than 20 %."

17. Warranty

17.1 Insofar as the creation of a work has been agreed and thus the law governing contracts for work and services applies the following shall apply: If our services are faulty then we are first of all entitled and obliged to subsequent satisfaction according to Section 634 No. 1 BGB. If the subsequent satisfaction finally fails the customer can according to Section 634 No. 3 cancel the contract or reduce the remuneration and according to Section 634 No. 4 BGB request damages. Claims of the customer for reimbursement of expenses according to Section 634 No. 2 BGB (self-execution) are excluded. Subclause 18 shall apply to claims for damages.

17.2 Insofar as we provide planning services without executing these and thus the law governing service contracts applies (e.g. in the event of a breach of our duties under Subclauses 5.2.1, 5.2.2 and 5.2.3) the following applies: If our services are faulty then we are first of all entitled and obliged to subsequent improvement. If the subsequent improvement finally fails the customer is entitled to damages according to Subclause 18.

17.3 Excluded from the warranty are damages as a result of natural wear and tear, faulty maintenance – insofar as we have not carried out this maintenance as per contract, failure to comply with operating equipment regulations, excessive use, unsuitable operating equipment, chemical or electrolytic influences, faulty construction and assembly work of third parties as well as other causes, for which we are not responsible.

17.4 The warranty shall lapse if the customer or third party makes changes or repairs to our services /products without our prior written consent unless the defect is not a result thereof.

17.5 Claims of the customer owing to defects of quality and title shall become statute-barred with the expiry of 12 months after the acceptance of the work or the knowledge of defects with the provision of planning services.

18. Liability

18.1 We shall be liable to an unlimited extent in case of wilful intent and gross negligence as well as with the injury to life, the body and the health as well as with the culpable breach of essential contractual obligations. Deemed as essential are such contractual obligations, the fulfilment of which makes the proper execution of the contract possible at all and the compliance with which the contractual partner may as a rule rely and depend on.

18.3 Incidentally our liability is excluded.

18.4 A liability according to the Product Liability Act remains unaffected.

18.5 The personal liability of our legal representatives and vicarious agents is limited as our own liability according to the afore-mentioned provisions.

19. Term of the contract; termination

19.1 Service agreements according to Subclause 5. shall come into force when signed by both parties and shall initially apply until the end of the calendar year, that follows the year in which the contract was concluded. The contractual relationship will subsequently be extended respectively by one further year unless it is terminated by one of the parties with a period of notice of 3 months to the end of the second or a following year. Contractual relationships can be terminated on the whole or only with regard to individual products.

19.2 The right to the extraordinary termination for an important reason remains unaffected.

20. Place of jurisdiction; applicable law

20.1 With all disputes ensuing from the contractual relationship if the orderer is a merchant, a legal entity under public law or a special fund under public law, the action is to be filed at the court that has jurisdiction for our headquarters. We are also entitled to file an action at the headquarters of the orderer.

20.2 The legal relationship is subject to the law of the Federal Republic of Germany. German international private law and the Viennese Convention of the United Nations concerning Contracts for the International Sale of Goods (CISG) will not apply.

RÖHM GmbH

89565 Sontheim (Germany)

Status: October 2015

RÖHM GmbH

Heinrich-Röhm-Straße 50

89567 Sontheim/Brenz

Germany

Tel +49 7325 16 0

Fax +49 7325 16 510

info@roehm.biz

www.roehm.biz



Id.-Nr. 1178261 / 1118 AU